

# LCD Projector

## CP-EX5001WN/CP-EW5001WN

### User's Manual (detailed) Operating Guide – Technical

#### Supported signals for COMPUTER IN

| Resolution (H x V) | Signal mode       | H. frequency<br>(kHz) | V. frequency<br>(Hz) | Rating |
|--------------------|-------------------|-----------------------|----------------------|--------|
| 720 x 400          | TEXT              | 37.9                  | 85                   | VESA   |
| 640 x 480          | VGA (60Hz)        | 31.5                  | 59.9                 | VESA   |
|                    | VGA (72Hz)        | 37.9                  | 72.8                 | VESA   |
|                    | VGA (75Hz)        | 37.5                  | 75                   | VESA   |
|                    | VGA (85Hz)        | 43.3                  | 85                   | VESA   |
| 800 x 600          | SVGA (56Hz)       | 35.2                  | 56.3                 | VESA   |
|                    | SVGA (60Hz)       | 37.9                  | 60.3                 | VESA   |
|                    | SVGA (72Hz)       | 48.1                  | 72.2                 | VESA   |
|                    | SVGA (75Hz)       | 46.9                  | 75                   | VESA   |
|                    | SVGA (85Hz)       | 53.7                  | 85.1                 | VESA   |
| 832 x 624          | Mac 16" mode      | 49.7                  | 74.5                 |        |
| 1024 x 768         | XGA (60Hz)        | 48.4                  | 60                   | VESA   |
|                    | XGA (70Hz)        | 56.5                  | 70.1                 | VESA   |
|                    | XGA (75Hz)        | 60                    | 75                   | VESA   |
|                    | XGA (85Hz)        | 68.7                  | 85                   | VESA   |
| 1152 x 864         | 1152 x 864 (75Hz) | 67.5                  | 75                   | VESA   |
| 1280 x 768         | WXGA (60Hz)       | 47.7                  | 60                   | VESA   |
| 1280 x 800         | 1280 x 800 (60Hz) | 49.7                  | 60                   | VESA   |
| 1280 x 1024        | SXGA (60Hz)       | 64                    | 60                   | VESA   |
|                    | SXGA (75Hz)       | 80                    | 75                   | VESA   |
|                    | SXGA (85Hz)       | 91.1                  | 85                   | VESA   |
| 1366 x 768         | WXGA (60Hz)       | 47.7                  | 59.8                 | VESA   |
| 1440 x 900         | WXGA+ (60Hz)      | 55.9                  | 59.9                 | VESA   |
| 1600 x 900         | WXGA++ (60Hz)     | 60                    | 60                   | VESA   |
| *1 1400 x 1050     | SXGA+ (60Hz)      | 65.2                  | 60                   | VESA   |
| *2 1680 x 1050     | WSXGA+ (60Hz)     | 65.3                  | 60                   | VESA   |
| 1600 x 1200        | UXGA (60Hz)       | 75                    | 60                   | VESA   |
| 1920 x 1080        | Full HD (60Hz)    | 67.5                  | 60                   | VESA   |

\*1) Only for [XGA Model]

\*2) Only for [WXGA Model]

## Supported signals for HDMI™

| Resolution (H x V) | Signal mode       | H. frequency<br>(kHz) | V. frequency<br>(Hz) | Rating |
|--------------------|-------------------|-----------------------|----------------------|--------|
| 720 x 400          | TEXT              | 37.9                  | 85                   | VESA   |
| 640 x 480          | VGA (60Hz)        | 31.5                  | 59.9                 | VESA   |
|                    | VGA (72Hz)        | 37.9                  | 72.8                 | VESA   |
|                    | VGA (75Hz)        | 37.5                  | 75                   | VESA   |
|                    | VGA (85Hz)        | 43.3                  | 85                   | VESA   |
| 800 x 600          | SVGA (56Hz)       | 35.2                  | 56.3                 | VESA   |
|                    | SVGA (60Hz)       | 37.9                  | 60.3                 | VESA   |
|                    | SVGA (72Hz)       | 48.1                  | 72.2                 | VESA   |
|                    | SVGA (75Hz)       | 46.9                  | 75                   | VESA   |
|                    | SVGA (85Hz)       | 53.7                  | 85.1                 | VESA   |
| 832 x 624          | Mac 16" mode      | 49.7                  | 74.5                 |        |
| 1024 x 768         | XGA (60Hz)        | 48.4                  | 60                   | VESA   |
|                    | XGA (70Hz)        | 56.5                  | 70.1                 | VESA   |
|                    | XGA (75Hz)        | 60                    | 75                   | VESA   |
|                    | XGA (85Hz)        | 68.7                  | 85                   | VESA   |
| 1152 x 864         | 1152 x 864 (75Hz) | 67.5                  | 75                   | VESA   |
| 1280 x 768         | WXGA (60Hz)       | 47.7                  | 60                   | VESA   |
| 1280 x 800         | 1280 x 800 (60Hz) | 49.7                  | 60                   | VESA   |
| 1280 x 1024        | SXGA (60Hz)       | 64                    | 60                   | VESA   |
|                    | SXGA (75Hz)       | 80                    | 75                   | VESA   |
|                    | SXGA (85Hz)       | 91.1                  | 85                   | VESA   |
| 1366 x 768         | WXGA (60Hz)       | 47.7                  | 59.8                 | VESA   |
| 1440 x 900         | WXGA+ (60Hz)      | 55.9                  | 59.9                 | VESA   |
| 1600 x 900         | WXGA++ (60Hz)     | 60                    | 60                   | VESA   |
| 1400 x 1050        | SXGA+ (60Hz)      | 65.2                  | 60                   | VESA   |
| 1680 x 1050        | WSXGA+ (60Hz)     | 65.3                  | 60                   | VESA   |
| 1600 x 1200        | UXGA (60Hz)       | 75                    | 60                   | VESA   |
| 720(1440) x 480i   | 480i              | 15.7                  | 60                   | CEA    |
| 720(1440) x 576i   | 576i              | 15.6                  | 50                   | CEA    |
| 720 x 480p         | 480p              | 31.5                  | 60                   | CEA    |
| 720 x 576p         | 576p              | 31.3                  | 50                   | CEA    |
| 1280 x 720p        | 720p (50Hz)       | 37.5                  | 50                   | CEA    |
|                    | 720p (60Hz)       | 45                    | 60                   | CEA    |
| 1920 x 1080i       | 1080i (50Hz)      | 28.1                  | 50                   | CEA    |
|                    | 1080i (60Hz)      | 33.8                  | 60                   | CEA    |
| 1920 x 1080p       | 1080p (50Hz)      | 56.3                  | 50                   | CEA    |
|                    | 1080p (60Hz)      | 67.5                  | 60                   | CEA    |

## Supported signals for MHL

| Resolution (H x V) | Signal mode  | H. frequency<br>(kHz) | V. frequency<br>(Hz) | Rating |
|--------------------|--------------|-----------------------|----------------------|--------|
| 640 x 480          | VGA (60Hz)   | 31.5                  | 59.9                 | VESA   |
| 720(1440) x 480i   | 480i         | 15.7                  | 60                   | CEA    |
| 720(1440) x 576i   | 576i         | 15.6                  | 50                   | CEA    |
| 720 x 480p         | 480p         | 31.5                  | 60                   | CEA    |
| 720 x 576p         | 576p         | 31.3                  | 50                   | CEA    |
| 1280 x 720p        | 720p (50Hz)  | 37.5                  | 50                   | CEA    |
|                    | 720p (60Hz)  | 45                    | 60                   | CEA    |
| 1920 x 1080i       | 1080i (50Hz) | 28.1                  | 50                   | CEA    |
|                    | 1080i (60Hz) | 33.8                  | 60                   | CEA    |
| 1920 x 1080p       | 1080p (50Hz) | 56.3                  | 50                   | CEA    |
|                    | 1080p (60Hz) | 67.5                  | 60                   | CEA    |

NOTE • Be sure to check jack type, signal level, timing and resolution before connecting this projector to a PC.

- Some PCs may have multiple display screen modes. Use of some of these modes will not be possible with this projector.
- Depending on the input signal, full-size display may not be possible in some cases. Refer to the number of display pixels above.
- The signal will be converted to the projector's panel resolution before being displayed. The best display performance will be achieved if the resolutions of the input signal and projector panel are identical.
- Automatic adjustment may not function correctly with some input signals.
- The image may not be displayed correctly when the input sync signal is a composite sync or a sync on G.
- The illustrations in this manual are for illustrative purposes. They may differ slightly from your projector.

## Connection to the ports

**NOTICE** ▶ Use the cables with straight plugs, not L-shaped ones, as the input ports of the projector are recessed.

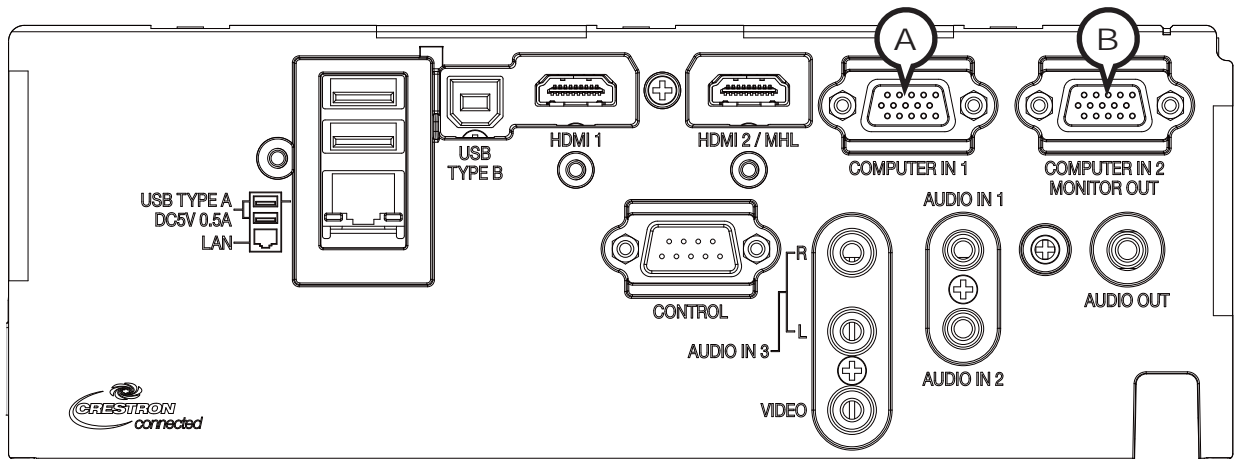

### ⒶCOMPUTER IN1, ⒷCOMPUTER IN2 / MONITOR OUT

D-sub 15pin mini shrink jack

<Computer signal>

- Video signal: RGB separate, Analog, 0.7Vp-p, 75Ω terminated (positive)
- H/V. sync. signal: TTL level (positive/negative)
- Composite sync. signal: TTL level

<Component video signal>

- Video signal:
  - Y, Analog, 1.0±0.1Vp-p with composite sync, 75Ω terminated
  - Cb/Pb, Analog, 0.7±0.1Vp-p, 75Ω terminated
  - Cr/Pr, Analog, 0.7±0.1Vp-p 75Ω terminated

System: 480i@60, 480p@60, 576i@50, 576p@50, 720p@50/60, 1080i@50/60, 1080p@50/60

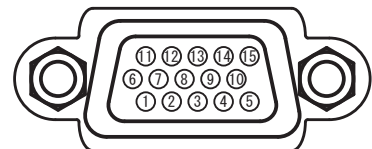

| Pin | Signal                    | Pin | Signal                                     |
|-----|---------------------------|-----|--|
| 1   | Video Red, Cr/Pr          | 9   | (No connection)                            |
| 2   | Video Green, Y            | 10  | Ground                                     |
| 3   | Video Blue, Cb/Pb         | 11  | (No connection)                            |
| 4   | (No connection)           | 12  | Ⓐ: SDA (DDC data), (No connection)         |
| 5   | Ground                    |     | Ⓑ: (No connection)                         |
| 6   | Ground Red, Ground Cr/Pr  | 13  | H. sync / Composite sync., (No connection) |
| 7   | Ground Green, Ground Y    | 14  | V. sync., (No connection)                  |
| 8   | Ground Blue, Ground Cb/Pb | 15  | Ⓐ: SCL (DDC clock), (No connection)        |
|     |                           |     | Ⓑ: (No connection)                         |

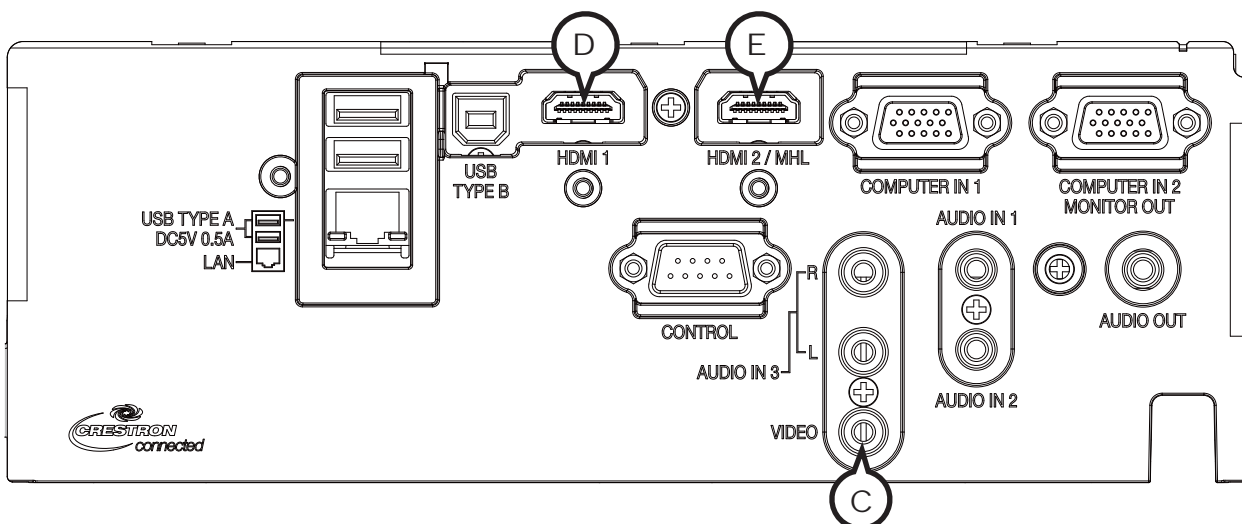

**Ⓒ VIDEO**

RCA jack

- System: NTSC, PAL, SECAM, PAL-M, PAL-N, NTSC4.43, PAL (60Hz)
- 1.0±0.1Vp-p, 75Ω terminator

**Ⓓ HDMI1, Ⓔ HDMI2/MHL**

- Type :Digital audio/video connector
- Audio signal : Linear PCM (Sampling rate; 32/44.1/48 kHz)

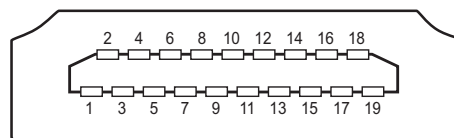

| Pin | Signal<br>(Top section : HDMI,<br>Bottom section : MHL) | Pin | Signal<br>(Top section : HDMI,<br>Bottom section : MHL) | Pin | Signal<br>(Top section : HDMI,<br>Bottom section : MHL) |
|-----|---|-----|---|-----|---|
| 1   | T.M.D.S. Data2 +<br>N.C.                                | 8   | T.M.D.S. Data0 Shield<br>MHL_Shield                     | 15  | SCL<br>CD_PULLUP  |
| 2   | T.M.D.S. Data2 Shield<br>CD_SENSE                       | 9   | T.M.D.S. Data0 -<br>MHL -                               | 16  | SDA<br>N.C.   |
| 3   | T.M.D.S. Data2 -<br>N.C.                                | 10  | T.M.D.S. Clock +<br>N.C.                                | 17  | DDC/CEC Ground<br>VBUS_CBUS_GND                         |
| 4   | T.M.D.S. Data1 +<br>N.C.                                | 11  | T.M.D.S. Clock Shield<br>TMDS_GND                       | 18  | +5V Power<br>VBUS                                       |
| 5   | T.M.D.S. Data1 Shield<br>TMDS_GND                       | 12  | T.M.D.S. Clock -<br>N.C.                                | 19  | Hot Plug Detect<br>CBUS                                 |
| 6   | T.M.D.S. Data1 -<br>N.C.                                | 13  | CEC<br>N.C.   |     |   |
| 7   | T.M.D.S. Data0 +<br>MHL+                                | 14  | Reserved(N.C. on device)<br>N.C.                        |     |   |

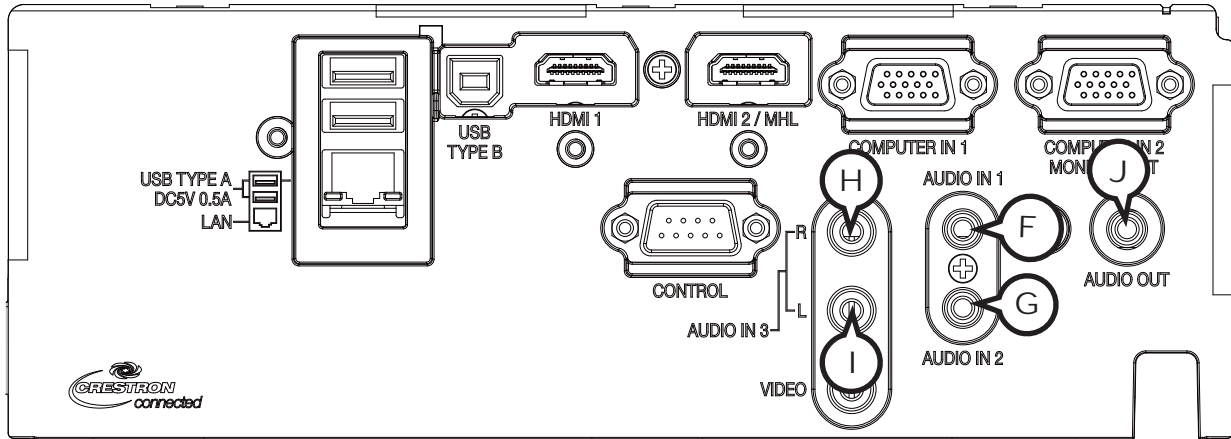

**ⒻAUDIO IN1, ⒼAUDIO IN2**

Ø3.5 stereo mini jack  
• 47kΩ terminator

**AUDIO IN3 ⒽR, ⒾL**

RCA jack x2  
• 47kΩ terminator

**ⒿAUDIO OUT**

Ø3.5 stereo mini jack  
• 1kΩ output impedance

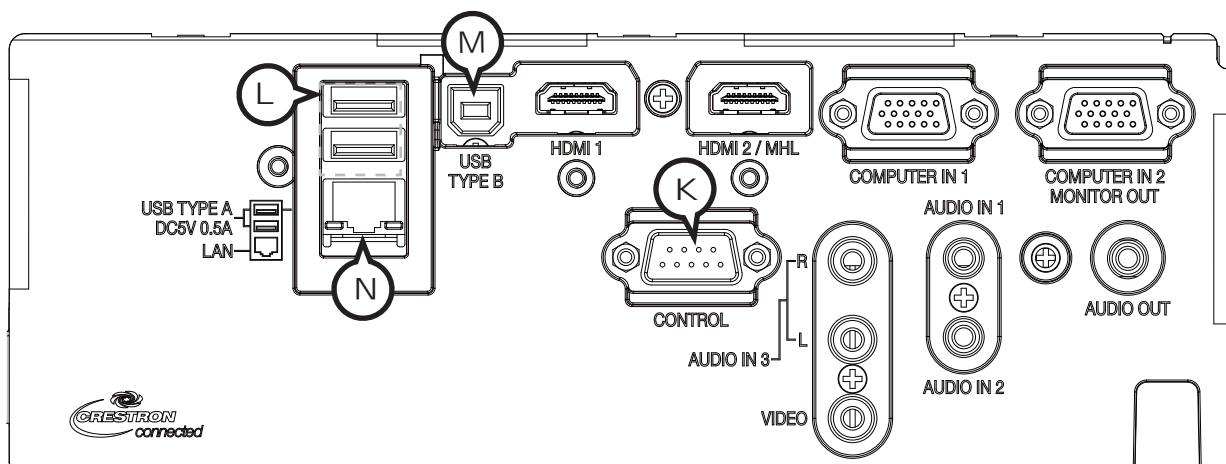

**(K) CONTROL**

D-sub 9pin plug

- About the details of RS-232C communication, please refer to the next chapter.

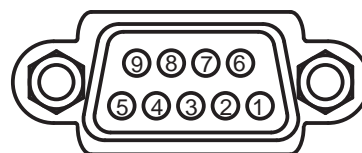

| Pin | Signal          | Pin | Signal          | Pin | Signal          |
|-----|-----------------|-----|-----------------|-----|-----------------|
| 1   | (No connection) | 4   | (No connection) | 7   | RTS             |
| 2   | RD              | 5   | Ground          | 8   | CTS             |
| 3   | TD              | 6   | (No connection) | 9   | (No connection) |

**(L) USB TYPE A (x2)**

USB A type jack

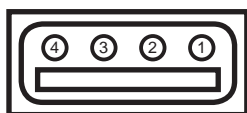

| Pin | Signal |
|-----|--------|
| 1   | +5V    |
| 2   | - Data |
| 3   | + Data |
| 4   | Ground |

**(M) USB TYPE B**

USB B type jack



| Pin | Signal |
|-----|--------|
| 1   | +5V    |
| 2   | - Data |
| 3   | + Data |
| 4   | Ground |

**(N) LAN**

RJ-45 jack

| Pin | Signal | Pin | Signal | Pin | Signal |
|-----|--------|-----|--------|-----|--------|
| 1   | TX+    | 4   | -      | 7   | -      |
| 2   | TX-    | 5   | -      | 8   | -      |
| 3   | RX+    | 6   | RX-    |     |        |

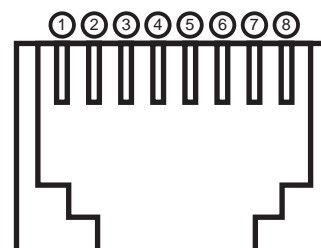

## To input component video signal to **COMPUTER IN** ports

ex.

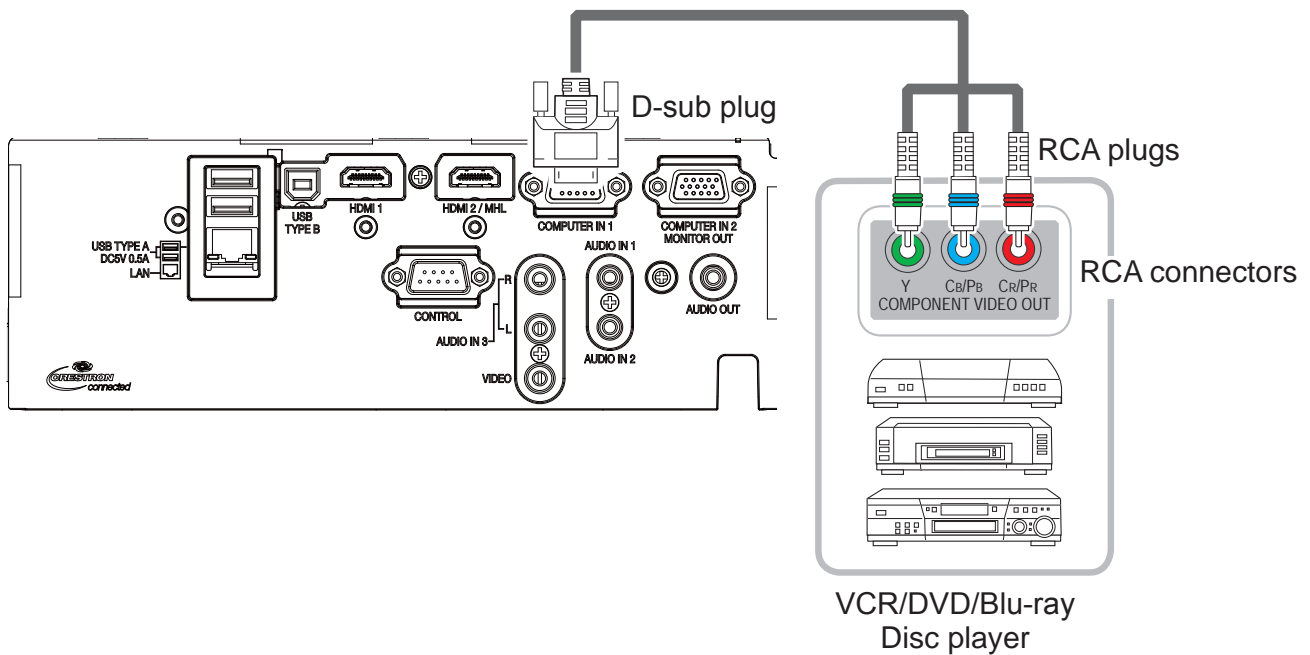

To input component video signal to the **COMPUTER IN1** or **IN2** port of the projector, use a RCA to D-sub cable or adapter.

For about the pin description of the required cable or adapter, refer to the descriptions about **COMPUTER IN1** and **IN2** port ([📖 4](#)).



## RS-232C Communication

When the projector connects to the computer by RS-232C communication, the projector can be controlled with RS-232C commands from the computer. For details of RS-232C commands, refer to RS-232C Communication / Network command table (📖 18).

### Connection

1. Turn off the projector and the computer.
2. Connect the projector's **CONTROL** port and the computer's RS-232C port with a RS-232C cable (cross). Use the cable that fulfills the specification shown in figure.
3. Turn the computer on, and after the computer has started up turn the projector on.
4. Set the COMMUNICATION TYPE to OFF. (📖 **OPTION menu - SERVICE - COMMUNICATION** in the **Operating Guide**)

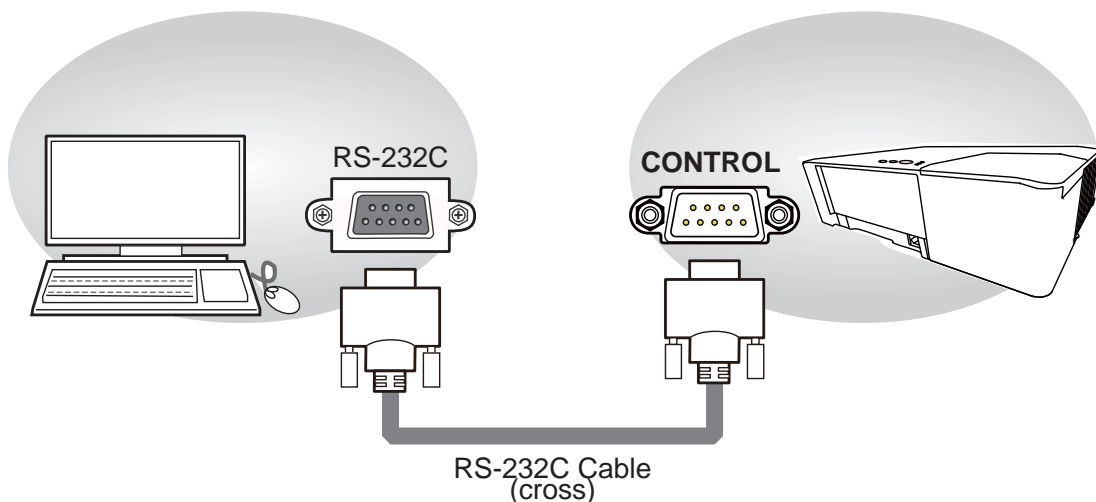

RS-232C port  
of the computer

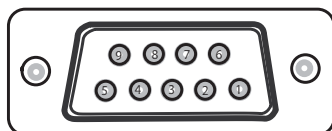

**CONTROL** port  
of the projector

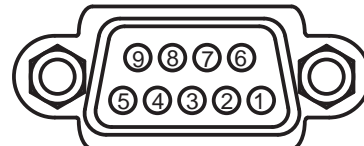

|         |         |
|---------|---------|
| CD (1)  | (1) —   |
| RD (2)  | (2) RD  |
| TD (3)  | (3) TD  |
| DTR (4) | (4) —   |
| GND (5) | (5) GND |
| DSR (6) | (6) —   |
| RTS (7) | (7) RTS |
| CTS (8) | (8) CTS |
| RI (9)  | (9) —   |

## Communication settings

1. Protocol  
19200bps,8N1

2. Command format ("h" shows hexadecimal)

| Byte Number  | 0           | 1   | 2      | 3         | 4   | 5        | 6    | 7      | 8   | 9    | 10   | 11           | 12   |
|--|-------------|-----|--------|-----------|-----|----------|------|--------|-----|------|------|--------------|------|
| Command<br><br>Action  | Header      |     |        |           |     |          | Data |        |     |      |      |              |      |
|  | Header code |     | Packet | Data size |     | CRC flag |      | Action |     | Type |      | Setting code |      |
|  | L           | H   |        | L         | H   | L        | H    | L      | H   | L    | H    | L            | H    |
| <SET>Change setting to desired value [(bL)(bH)] by [(cL)(cH)]. | BEh         | EFh | 03h    | 06h       | 00h | (aL)     | (aH) | 01h    | 00h | (bL) | (bH) | (cL)         | (cH) |
| <GET>Read projector internal setup value [(bL)(bH)].           |             |     |        |           |     | (aL)     | (aH) | 02h    | 00h | (bL) | (bH) | 00h          | 00h  |
| <INCREMENT> Increment setup value [(bL)(bH)] by 1.             |             |     |        |           |     | (aL)     | (aH) | 04h    | 00h | (bL) | (bH) | 00h          | 00h  |
| <DECREMENT> Decrement setup value [(bL)(bH)] by 1.             |             |     |        |           |     | (aL)     | (aH) | 05h    | 00h | (bL) | (bH) | 00h          | 00h  |
| <EXECUTE> Run a command [(bL)(bH)].                            |             |     |        |           |     | (aL)     | (aH) | 06h    | 00h | (bL) | (bH) | 00h          | 00h  |

### [Header code], [Packet], [Data size]

Set [BEh, EFh, 03h, 06h, 00h] to byte number 0 ~ 4.

### [CRC flag]

For byte number 5, 6, refer to RS-232C Communication / Network command table (📖 18).

### [Action]

Set functional code to byte number 7, 8.

<SET> = [01h, 00h], <GET> = [02h, 00h], <INCREMENT> = [04h, 00h]

<DECREMENT> = [05h, 00h], <EXECUTE> = [06h, 00h]

Refer to the command table above.

### [Type], [Setting code]

For byte number 9 ~ 12, refer to RS-232C Communication / Network command table (📖 18).

### 3. Response code / Error code ("h" shows hexadecimal)

#### (1) ACK reply : 06h

When the projector receives the Set, Increment, Decrement or Execute command correctly, the projector changes the setting data for the specified item by [Type], and it returns the code.

#### (2) NAK reply : 15h

When the projector cannot understand the received command, the projector returns the error code.

In such a case, check the sending code and send the same command again.

#### (3) Error reply : 1Ch + 0000h

When the projector cannot execute the received command for any reasons, the projector returns the error code.

In such a case, check the sending code and the setting status of the projector.

#### (4) Data reply : 1Dh + xxxxh

When the projector receives the GET command correctly, the projector returns the response code and 2 bytes of data.

NOTE • For connecting the projector to your devices, please read the manual for each devices, and connect them correctly with suitable cables.

- Operation cannot be guaranteed when the projector receives an undefined command or data.
- Provide an interval of at least 40ms between the response code and any other code.
- The projector outputs test data when the power supply is switched ON, and when the lamp is lit. Ignore this data.
- Commands are not accepted during warm-up.
- When the data length is greater than indicated by the data length code, the projector ignore the excess data code. Conversely when the data length is shorter than indicated by the data length code, the projector returns the error code to the computer.

## Command Control via the Network

When the projector connects network, the projector can be controlled with RS-232C commands from the computer with web browser.

For details of RS-232C commands, refer to RS-232C Communication / Network command table ([📖 18](#)).

**NOTE** • If data is transferred via wireless and wired LAN at the same time, the projector may not be able to process the data correctly.

### Connection

1. Turn off the projector and the computer.
2. If you use wired LAN, connect the projector's **LAN** port to the computer's LAN port with a LAN cable. Use the cable that fulfills the specification shown in figure. If you use wireless LAN, insert the USB wireless adapter into the projector's **USB TYPE A** port.
3. Turn the computer on, and after the computer has started up turn the projector on.

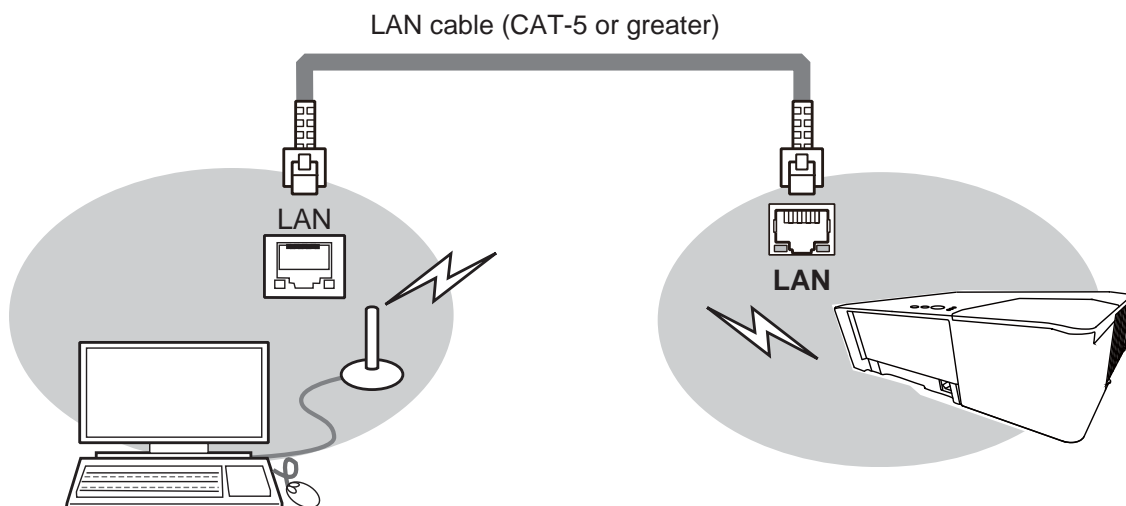

## Communication Port

The following two ports are assigned for the command control.

TCP #23

TCP #9715

Configure the following items from a web browser when command control is used.

| Port Settings                             |                |  |
|---|----------------|--|
| <b>Network Control Port1 (Port: 23)</b>   | Port open      | Click the <b>[Enable]</b> check box to open <b>[Network Control Port1 (Port: 23)]</b> to use TCP #23. Default setting is "Enable".         |
|   | Authentication | Click the <b>[Enable]</b> check box for the <b>[Authentication]</b> setting when authentication is required. Default setting is "Disable". |
| <b>Network Control Port2 (Port: 9715)</b> | Port open      | Click the <b>[Enable]</b> check box to open <b>[Network Control Port2 (Port: 9715)]</b> to use TCP #9715. Default setting is "Enable".     |
|   | Authentication | Click the <b>[Enable]</b> check box for the <b>[Authentication]</b> setting when authentication is required. Default setting is "Enable".  |

When the authentication setting is enabled, the following settings are required.

| Security Settings      |                                  |  |
|------------------------|----------------------------------|--|
| <b>Network Control</b> | Authentication Password          | Enter the desired authentication password. Confirm this setting will be the same for <b>[Network Control Port1 (Port: 23)]</b> and <b>[Network Control Port2 (Port: 9715)]</b> . Default setting is blank. |
|                        | Re-enter Authentication Password |  |

## Command control settings

### [TCP #23]

#### 1. Command format

Same as RS-232C communication, refer to RS-232C Communication command format.

#### 2. Response code / Error code ("h" shows hexadecimal)

Four of the response / error code used for TCP#23 are the same as RS-232C Communication (1)~(4). One authentication error reply (5) is added.

#### (1) ACK reply : 06h

Refer to RS-232C communication (📖 11).

#### (2) NAK reply : 15h

Refer to RS-232C communication (📖 11).

#### (3) Error reply : 1Ch + 0000h

Refer to RS-232C communication (📖 11).

#### (4) Data reply : 1Dh + xxxh

Refer to RS-232C communication (📖 11).

#### (5) Authentication error reply : 1Fh + 0400h

When authentication error occurred, the projector returns the error code.

### [TCP #9715]

#### 1. Command format

The commands some datum are added to the head and the end of the ones of TCP#9715 are used.

| Header | Data length | RS-232C command | Check sum | Connection ID |
|--------|-------------|-----------------|-----------|---------------|
| 0x02   | 0x0D        | 13 bytes        | 1 byte    | 1 byte        |

#### [Header]

02, Fixed

#### [Data Length]

RS-232C commands byte length (0x0D, Fixed)

#### [RS-232C commands]

Refer to RS-232C Communication command format (📖 10).

#### [Check Sum]

This is the value to make zero on the addition of the lower 8 bits from the header to the checksum.

#### [Connection ID]

Random value from 0 to 255 (This value is attached to the reply data).

NOTE • Operation cannot be guaranteed when the projector receives an undefined command or data.

- Provide an interval of at least 40ms between the response code and any other code.
- Commands are not accepted during warm-up.

## 2. Response code / Error code ("h" shows hexadecimal)

The connection ID is attached for the TCP#23's response / error codes are used. The connection ID is same as the sending command format.

**(1) ACK reply : 06h + yyh** (yyh : connection ID)

**(2) NAK reply : 15h + yyh**

**(3) Error reply : 1Ch + 0000h + yyh**

**(4) Data reply : 1Dh + xxxxh + yyh**

**(5) Authentication error reply : 1Fh + 0400h + yyh**

**(6) Projector busy reply: 1Fh + xxxxh + yyh**

When the projector is too busy to receive the command, the projector returns the error code.

In such a case, check the sending code and send the same command again.

## Automatic Connection Break

The TCP connection will be automatically disconnected after there is no communication for 30 seconds after being established.

## Authentication

The projector does not accept commands without authentication success when authentication is enabled. The projector uses a challenge response type authentication with an MD5 (Message Digest 5) algorithm. When the projector is using a LAN, a random 8 bytes will be returned if authentication is enabled. Bind this received 8 bytes and the authentication password and digest this data with the MD5 algorithm and add this in front of the commands to send.

Following is a sample if the authentication password is set to "password" and the random 8 bytes are "a572f60c".

- 1) Select the projector.
- 2) Receive the random 8 bytes "a572f60c" from the projector.
- 3) Bind the random 8 bytes "a572f60c" and the authentication password "password" and it becomes "a572f60cpassword".
- 4) Digest this bind "a572f60cpassword" with MD5 algorithm.  
It will be "e3d97429adffa11bce1f7275813d4bde".
- 5) Add this "e3d97429adffa11bce1f7275813d4bde" in front of the commands and send the data.  
Send "e3d97429adffa11bce1f7275813d4bde"+command.
- 6) When the sending data is correct, the command will be performed and the reply data will be returned. Otherwise, an authentication error will be returned.

NOTE • As for the transmission of the second or subsequent commands, the authentication data can be omitted when the same connection.

## Network Bridge Communication

This projector is equipped with NETWORK BRIDGE function. When the projector connects to the computer by wired or wireless LAN communication, an external device that is connected with this projector by RS-232C communication can be controlled from the computer as a network terminal. For details, see the **7. Network Bridge** function in the **Network Guide**.

**NOTE** • If data is transferred via wireless and wired LAN at the same time, the projector may not be able to process the data correctly.

### Connection

1. If you use wired LAN, connect the computer's LAN port and the projector's **LAN** port with a LAN cable. Use the cable that fulfills the specification shown in figure. If you use wireless LAN, insert the USB wireless adapter into the projector's **USB TYPE A** port.
2. Connect the projector's **CONTROL** port and the RS-232C port of the devices that you want to control with a RS-232C cable.
3. Turn the computer on, and after the computer has started up turn the projector on.
4. Set the COMMUNICATION TYPE to NETWORK BRIDGE. ( **OPTION menu - SERVICE - COMMUNICATION** in the **Operating Guide**)

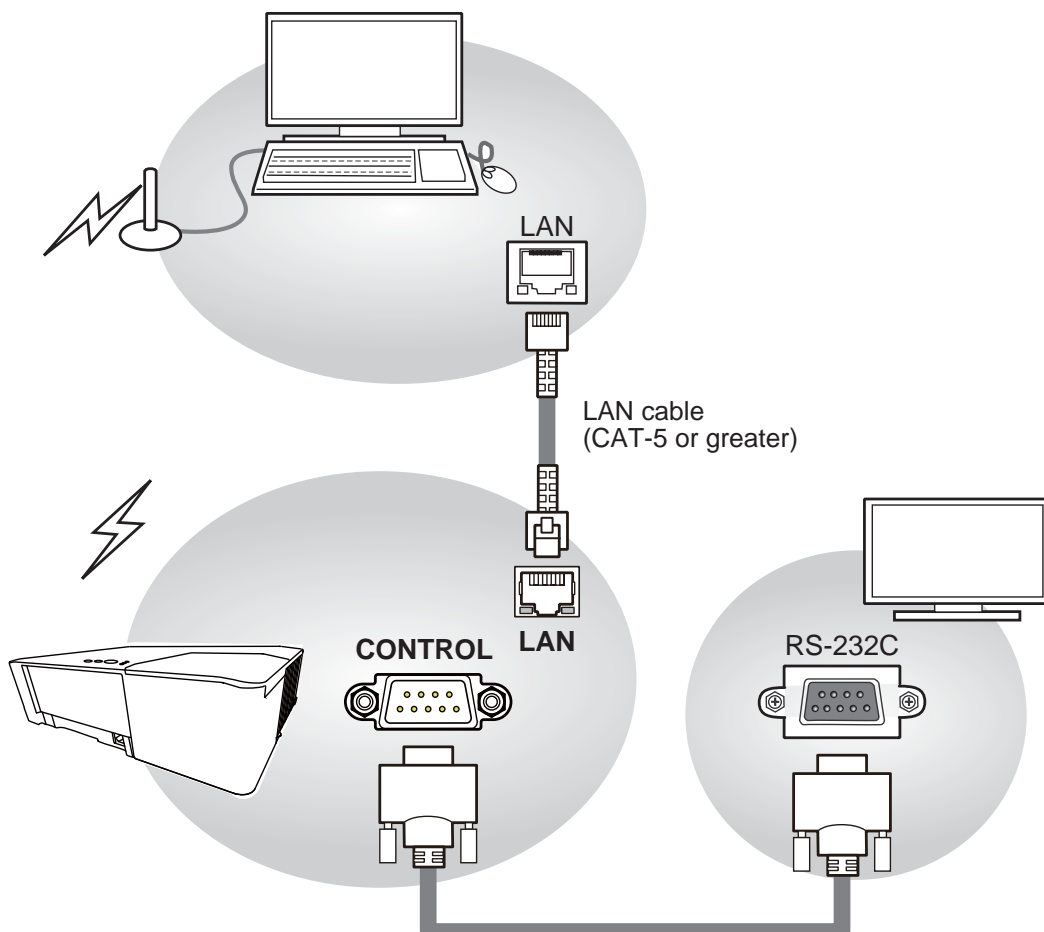



## Communication settings

For communication setting, use the OPTION - SERVICE - COMMUNICATION menu. ( **OPTION menu - SERVICE - COMMUNICATION** in the **Operating Guide**)

| Item                | Condition                               |
|---------------------|---|
| BAUD RATE           | 4800bps / 9600bps / 19200bps / 38400bps |
| Data length         | 8 bit (fixed)                           |
| PARITY              | NONE/ODD/EVEN                           |
| Start bit           | 1 bit (fixed)                           |
| Stop bit            | 1 bit (fixed)                           |
| Transmission method | HALF-DUPLEX/FULL-DUPLEX                 |

- NOTE • For connecting the projector to your devices, please read the manual for each devices, and connect them correctly with suitable cables.
- Turn off (the power of) both the projector and other devices and unplug before connecting them.
  - For details of Transmission method, refer to **7.4 Transmission method** in the **Network Guide**.

## RS-232C Communication / Network command table

| Names              | Operation Type | Header           |                  |              |                | Command Data |                |       |       |
|--------------------|----------------|------------------|------------------|--------------|----------------|--------------|----------------|-------|-------|
|                    |                | CRC              | Action           | Type         | Setting Code   |              |                |       |       |
| Power              | Set            | Turn off         | BE EF            | 03           | 06 00          | 2A D3        | 01 00          | 00 60 | 00 00 |
|                    |                | Turn on          | BE EF            | 03           | 06 00          | BA D2        | 01 00          | 00 60 | 01 00 |
|                    | Get            | BE EF            | 03               | 06 00        | 19 D3          | 02 00        | 00 60          | 00 00 |       |
|                    |                |                  | [Example return] |              |                |              |                |       |       |
|                    |                |                  | 00 00            | 01 00        | 02 00          |              |                |       |       |
|                    |                |                  | [Off]            | [On]         | [Cool down]    |              |                |       |       |
| Input Source       | Set            | COMPUTER IN1     | BE EF            | 03           | 06 00          | FE D2        | 01 00          | 00 20 | 00 00 |
|                    |                | COMPUTER IN2     | BE EF            | 03           | 06 00          | 3E D0        | 01 00          | 00 20 | 04 00 |
|                    |                | HDMI1            | BE EF            | 03           | 06 00          | 0E D2        | 01 00          | 00 20 | 03 00 |
|                    |                | HDMI2/MHL        | BE EF            | 03           | 06 00          | 6E D6        | 01 00          | 00 20 | 0D 00 |
|                    |                | VIDEO            | BE EF            | 03           | 06 00          | 6E D3        | 01 00          | 00 20 | 01 00 |
|                    |                | LAN              | BE EF            | 03           | 06 00          | CE D5        | 01 00          | 00 20 | 0B 00 |
|                    |                | USB TYPE A       | BE EF            | 03           | 06 00          | 5E D1        | 01 00          | 00 20 | 06 00 |
|                    | USB TYPE B     | BE EF            | 03               | 06 00        | FE D7          | 01 00        | 00 20          | 0C 00 |       |
|                    | Get            | BE EF            | 03               | 06 00        | CD D2          | 02 00        | 00 20          | 00 00 |       |
| Error Status       | Get            | BE EF            | 03               | 06 00        | D9 D8          | 02 00        | 20 60          | 00 00 |       |
|                    |                |                  | [Example return] |              |                |              |                |       |       |
|                    |                | 00 00            | 01 00            | 02 00        | 03 00          |              |                |       |       |
|                    |                | [Normal]         | [Cover error]    | [Fan error]  | [Lamp error]   |              |                |       |       |
|                    |                | 04 00            | 05 00            | 07 00        | 08 00          |              |                |       |       |
|                    |                | [Temp error]     | [Air flow error] | [Cold error] | [Filter error] |              |                |       |       |
| MAGNIFY            | Get            | BE EF            | 03               | 06 00        | 7C D2          | 02 00        | 07 30          | 00 00 |       |
|                    | Increment      | BE EF            | 03               | 06 00        | 1A D2          | 04 00        | 07 30          | 00 00 |       |
|                    | Decrement      | BE EF            | 03               | 06 00        | CB D3          | 05 00        | 07 30          | 00 00 |       |
| Magnify Position H | Get            | BE EF            | 03               | 06 00        | C8 D7          | 02 00        | 10 30          | 00 00 |       |
|                    | Increment      | BE EF            | 03               | 06 00        | AE D7          | 04 00        | 10 30          | 00 00 |       |
|                    | Decrement      | BE EF            | 03               | 06 00        | 7F D6          | 05 00        | 10 30          | 00 00 |       |
| Magnify Position V | Get            | BE EF            | 03               | 06 00        | 34 D6          | 02 00        | 11 30          | 00 00 |       |
|                    | Increment      | BE EF            | 03               | 06 00        | 52 D6          | 04 00        | 11 30          | 00 00 |       |
|                    | Decrement      | BE EF            | 03               | 06 00        | 83 D7          | 05 00        | 11 30          | 00 00 |       |
| FREEZE             | Set            | NORMAL           | BE EF            | 03           | 06 00          | 83 D2        | 01 00          | 02 30 | 00 00 |
|                    |                | FREEZE           | BE EF            | 03           | 06 00          | 13 D3        | 01 00          | 02 30 | 01 00 |
|                    | Get            | BE EF            | 03               | 06 00        | B0 D2          | 02 00        | 02 30          | 00 00 |       |
| PICTURE MODE       | Set            | STANDARD         | BE EF            | 03           | 06 00          | 83 F5        | 01 00          | BA 30 | 06 00 |
|                    |                | CINEMA           | BE EF            | 03           | 06 00          | B3 F7        | 01 00          | BA 30 | 01 00 |
|                    |                | DYNAMIC          | BE EF            | 03           | 06 00          | E3 F4        | 01 00          | BA 30 | 04 00 |
|                    |                | BOARD(BLACK)     | BE EF            | 03           | 06 00          | E3 EF        | 01 00          | BA 30 | 20 00 |
|                    |                | BOARD(GREEN)     | BE EF            | 03           | 06 00          | 73 EE        | 01 00          | BA 30 | 21 00 |
|                    |                | WHITEBOARD       | BE EF            | 03           | 06 00          | 83 EE        | 01 00          | BA 30 | 22 00 |
|                    |                | DAYTIME          | BE EF            | 03           | 06 00          | E3 C7        | 01 00          | BA 30 | 40 00 |
|                    |                | PHOTO            | BE EF            | 03           | 06 00          | 73 F5        | 01 00          | BA 30 | 05 00 |
|                    | DICOM SIM.     | BE EF            | 03               | 06 00        | 73 C6          | 01 00        | BA 30          | 41 00 |       |
|                    | Get            | BE EF            | 03               | 06 00        | 10 F6          | 02 00        | BA 30          | 00 00 |       |
|                    |                | [Example return] |                  |              |                |              |                |       |       |
|                    |                | 06 00            | 01 00            | 04 00        | 10 00          | 05 00        | 20 00          |       |       |
|                    |                | [Standard]       | [Cinema]         | [Dynamic]    | [Custom]       | [PHOTO]      | [BOARD(BLACK)] |       |       |
|                    |                | 21 00            | 22 00            | 40 00        | 41 00          |              |                |       |       |
|                    |                | [BOARD(GREEN)]   | [WHITEBOARD]     | [DAY TIME]   | [DICOM SIM.]   |              |                |       |       |

(continued on next page)

## RS-232C Communication / Network command table (continued)

| Names                    | Operation Type | Header              |       |       |       | Command Data |       |              |       |
|--------------------------|----------------|---------------------|-------|-------|-------|--------------|-------|--------------|-------|
|                          |                |                     |       |       | CRC   | Action       | Type  | Setting Code |       |
| BRIGHTNESS               | Get            | BE EF               | 03    | 06 00 | 89 D2 | 02 00        | 03 20 | 00 00        |       |
|                          | Increment      | BE EF               | 03    | 06 00 | EF D2 | 04 00        | 03 20 | 00 00        |       |
|                          | Decrement      | BE EF               | 03    | 06 00 | 3E D3 | 05 00        | 03 20 | 00 00        |       |
| BRIGHTNESS Reset         | Execute        | BE EF               | 03    | 06 00 | 58 D3 | 06 00        | 00 70 | 00 00        |       |
| CONTRAST                 | Get            | BE EF               | 03    | 06 00 | FD D3 | 02 00        | 04 20 | 00 00        |       |
|                          | Increment      | BE EF               | 03    | 06 00 | 9B D3 | 04 00        | 04 20 | 00 00        |       |
|                          | Decrement      | BE EF               | 03    | 06 00 | 4A D2 | 05 00        | 04 20 | 00 00        |       |
| CONTRAST Reset           | Execute        | BE EF               | 03    | 06 00 | A4 D2 | 06 00        | 01 70 | 00 00        |       |
| ACCENTUALIZER            | Get            | BE EF               | 03    | 06 00 | 5D 70 | 02 00        | 0C 22 | 00 00        |       |
|                          | Increment      | BE EF               | 03    | 06 00 | 3B 70 | 04 00        | 0C 22 | 00 00        |       |
|                          | Decrement      | BE EF               | 03    | 06 00 | EA 71 | 05 00        | 0C 22 | 00 00        |       |
| ACCENTUALIZER Reset      | Execute        | BE EF               | 03    | 06 00 | C8 DB | 06 00        | 2C 70 | 00 00        |       |
| HDCR                     | Get            | BE EF               | 03    | 06 00 | A1 71 | 02 00        | 0D 22 | 00 00        |       |
|                          | Increment      | BE EF               | 03    | 06 00 | C7 71 | 04 00        | 0D 22 | 00 00        |       |
|                          | Decrement      | BE EF               | 03    | 06 00 | 16 70 | 05 00        | 0D 22 | 00 00        |       |
| HDCR Reset               | Execute        | BE EF               | 03    | 06 00 | 34 DA | 06 00        | 2D 70 | 00 00        |       |
| GAMMA                    | Set            | DEFAULT-1           | BE EF | 03    | 06 00 | 07 E9        | 01 00 | A1 30        | 20 00 |
|                          |                | CUSTOM-1            | BE EF | 03    | 06 00 | 07 FD        | 01 00 | A1 30        | 10 00 |
|                          |                | DEFAULT-2           | BE EF | 03    | 06 00 | 97 E8        | 01 00 | A1 30        | 21 00 |
|                          |                | CUSTOM-2            | BE EF | 03    | 06 00 | 97 FC        | 01 00 | A1 30        | 11 00 |
|                          |                | DEFAULT-3           | BE EF | 03    | 06 00 | 67 E8        | 01 00 | A1 30        | 22 00 |
|                          |                | CUSTOM-3            | BE EF | 03    | 06 00 | 67 FC        | 01 00 | A1 30        | 12 00 |
|                          |                | DEFAULT-4           | BE EF | 03    | 06 00 | F7 E9        | 01 00 | A1 30        | 23 00 |
|                          |                | CUSTOM-4            | BE EF | 03    | 06 00 | F7 FD        | 01 00 | A1 30        | 13 00 |
|                          |                | DEFAULT-5           | BE EF | 03    | 06 00 | C7 EB        | 01 00 | A1 30        | 24 00 |
|                          |                | CUSTOM-5            | BE EF | 03    | 06 00 | C7 FF        | 01 00 | A1 30        | 14 00 |
|                          |                | DEFAULT-6           | BE EF | 03    | 06 00 | 57 EA        | 01 00 | A1 30        | 25 00 |
|                          |                | CUSTOM-6            | BE EF | 03    | 06 00 | 57 FE        | 01 00 | A1 30        | 15 00 |
|                          |                | DEFAULT-7           | BE EF | 03    | 06 00 | A7 EA        | 01 00 | A1 30        | 26 00 |
|                          |                | CUSTOM-7            | BE EF | 03    | 06 00 | A7 FE        | 01 00 | A1 30        | 16 00 |
|                          |                | DEFAULT-8           | BE EF | 03    | 06 00 | 37 EB        | 01 00 | A1 30        | 27 00 |
|                          |                | CUSTOM-8            | BE EF | 03    | 06 00 | 37 FF        | 01 00 | A1 30        | 17 00 |
|                          | Get            | BE EF               | 03    | 06 00 | F4 F0 | 02 00        | A1 30 | 00 00        |       |
| User Gamma Pattern       | Set            | Off                 | BE EF | 03    | 06 00 | FB FA        | 01 00 | 80 30        | 00 00 |
|                          |                | 9 steps gray scale  | BE EF | 03    | 06 00 | 6B FB        | 01 00 | 80 30        | 01 00 |
|                          |                | 15 steps gray scale | BE EF | 03    | 06 00 | 9B FB        | 01 00 | 80 30        | 02 00 |
|                          |                | Ramp                | BE EF | 03    | 06 00 | 0B FA        | 01 00 | 80 30        | 03 00 |
|                          | Get            | BE EF               | 03    | 06 00 | C8 FA | 02 00        | 80 30 | 00 00        |       |
| User Gamma Point 1       | Get            | BE EF               | 03    | 06 00 | 08 FE | 02 00        | 90 30 | 00 00        |       |
|                          | Increment      | BE EF               | 03    | 06 00 | 6E FE | 04 00        | 90 30 | 00 00        |       |
|                          | Decrement      | BE EF               | 03    | 06 00 | BF FF | 05 00        | 90 30 | 00 00        |       |
| User Gamma Point 1 Reset | Execute        | BE EF               | 03    | 06 00 | 58 C2 | 06 00        | 50 70 | 00 00        |       |
| User Gamma Point 2       | Get            | BE EF               | 03    | 06 00 | F4 FF | 02 00        | 91 30 | 00 00        |       |
|                          | Increment      | BE EF               | 03    | 06 00 | 92 FF | 04 00        | 91 30 | 00 00        |       |
|                          | Decrement      | BE EF               | 03    | 06 00 | 43 FE | 05 00        | 91 30 | 00 00        |       |
| User Gamma Point 2 Reset | Execute        | BE EF               | 03    | 06 00 | A4 C3 | 06 00        | 51 70 | 00 00        |       |

(continued on next page)

RS-232C Communication / Network command table (continued)

| Names                    | Operation Type | Header        |       |       |       | Command Data |       |              |       |
|--------------------------|----------------|---------------|-------|-------|-------|--------------|-------|--------------|-------|
|                          |                |               |       |       | CRC   | Action       | Type  | Setting Code |       |
| User Gamma Point 3       | Get            | BE EF         | 03    | 06 00 | B0 FF | 02 00        | 92 30 | 00 00        |       |
|                          | Increment      | BE EF         | 03    | 06 00 | D6 FF | 04 00        | 92 30 | 00 00        |       |
|                          | Decrement      | BE EF         | 03    | 06 00 | 07 FE | 05 00        | 92 30 | 00 00        |       |
| User Gamma Point 3 Reset | Execute        | BE EF         | 03    | 06 00 | E0 C3 | 06 00        | 52 70 | 00 00        |       |
| User Gamma Point 4       | Get            | BE EF         | 03    | 06 00 | 4C FE | 02 00        | 93 30 | 00 00        |       |
|                          | Increment      | BE EF         | 03    | 06 00 | 2A FE | 04 00        | 93 30 | 00 00        |       |
|                          | Decrement      | BE EF         | 03    | 06 00 | FB FF | 05 00        | 93 30 | 00 00        |       |
| User Gamma Point 4 Reset | Execute        | BE EF         | 03    | 06 00 | 1C C2 | 06 00        | 53 70 | 00 00        |       |
| User Gamma Point 5       | Get            | BE EF         | 03    | 06 00 | 38 FF | 02 00        | 94 30 | 00 00        |       |
|                          | Increment      | BE EF         | 03    | 06 00 | 5E FF | 04 00        | 94 30 | 00 00        |       |
|                          | Decrement      | BE EF         | 03    | 06 00 | 8F FE | 05 00        | 94 30 | 00 00        |       |
| User Gamma Point 5 Reset | Execute        | BE EF         | 03    | 06 00 | 68 C3 | 06 00        | 54 70 | 00 00        |       |
| User Gamma Point 6       | Get            | BE EF         | 03    | 06 00 | C4 FE | 02 00        | 95 30 | 00 00        |       |
|                          | Increment      | BE EF         | 03    | 06 00 | A2 FE | 04 00        | 95 30 | 00 00        |       |
|                          | Decrement      | BE EF         | 03    | 06 00 | 73 FF | 05 00        | 95 30 | 00 00        |       |
| User Gamma Point 6 Reset | Execute        | BE EF         | 03    | 06 00 | 94 C2 | 06 00        | 55 70 | 00 00        |       |
| User Gamma Point 7       | Get            | BE EF         | 03    | 06 00 | 80 FE | 02 00        | 96 30 | 00 00        |       |
|                          | Increment      | BE EF         | 03    | 06 00 | E6 FE | 04 00        | 96 30 | 00 00        |       |
|                          | Decrement      | BE EF         | 03    | 06 00 | 37 FF | 05 00        | 96 30 | 00 00        |       |
| User Gamma Point 7 Reset | Execute        | BE EF         | 03    | 06 00 | D0 C2 | 06 00        | 56 70 | 00 00        |       |
| User Gamma Point 8       | Get            | BE EF         | 03    | 06 00 | 7C FF | 02 00        | 97 30 | 00 00        |       |
|                          | Increment      | BE EF         | 03    | 06 00 | 1A FF | 04 00        | 97 30 | 00 00        |       |
|                          | Decrement      | BE EF         | 03    | 06 00 | CB FE | 05 00        | 97 30 | 00 00        |       |
| User Gamma Point 8 Reset | Execute        | BE EF         | 03    | 06 00 | 2C C3 | 06 00        | 57 70 | 00 00        |       |
| COLOR TEMP               | Set            | 1 HIGH        | BE EF | 03    | 06 00 | 0B F5        | 01 00 | B0 30        | 03 00 |
|                          |                | 1 CUSTOM      | BE EF | 03    | 06 00 | CB F8        | 01 00 | B0 30        | 13 00 |
|                          |                | 2 MID-1       | BE EF | 03    | 06 00 | 9B F4        | 01 00 | B0 30        | 02 00 |
|                          |                | 2 CUSTOM      | BE EF | 03    | 06 00 | 5B F9        | 01 00 | B0 30        | 12 00 |
|                          |                | 3 MID-2       | BE EF | 03    | 06 00 | 3B F7        | 01 00 | B0 30        | 04 00 |
|                          |                | 3 CUSTUM      | BE EF | 03    | 06 00 | FB FA        | 01 00 | B0 30        | 14 00 |
|                          |                | 4 LOW         | BE EF | 03    | 06 00 | 6B F4        | 01 00 | B0 30        | 01 00 |
|                          |                | 4 CUSTOM      | BE EF | 03    | 06 00 | AB F9        | 01 00 | B0 30        | 11 00 |
|                          |                | 5 Hi-BRIGHT-1 | BE EF | 03    | 06 00 | 3B F2        | 01 00 | B0 30        | 08 00 |
|                          |                | 5 CUSTOM      | BE EF | 03    | 06 00 | FB FF        | 01 00 | B0 30        | 18 00 |
|                          |                | 6 Hi-BRIGHT-2 | BE EF | 03    | 06 00 | AB F3        | 01 00 | B0 30        | 09 00 |
|                          |                | 6 CUSTOM      | BE EF | 03    | 06 00 | 6B FE        | 01 00 | B0 30        | 19 00 |
|                          |                | 7 Hi-BRIGHT-3 | BE EF | 03    | 06 00 | 5B F3        | 01 00 | B0 30        | 0A 00 |
|                          |                | 7 CUSTOM      | BE EF | 03    | 06 00 | 9B FE        | 01 00 | B0 30        | 1A 00 |
|                          | 8 Hi-BRIGHT-4  | BE EF         | 03    | 06 00 | CB F2 | 01 00        | B0 30 | 0B 00        |       |
| 8 CUSTOM                 | BE EF          | 03            | 06 00 | 0B FF | 01 00 | B0 30        | 1B 00 |              |       |
|                          | Get            | BE EF         | 03    | 06 00 | C8 F5 | 02 00        | B0 30 | 00 00        |       |
| COLOR TEMP GAIN R        | Get            | BE EF         | 03    | 06 00 | 34 F4 | 02 00        | B1 30 | 00 00        |       |
|                          | Increment      | BE EF         | 03    | 06 00 | 52 F4 | 04 00        | B1 30 | 00 00        |       |
|                          | Decrement      | BE EF         | 03    | 06 00 | 83 F5 | 05 00        | B1 30 | 00 00        |       |
| COLOR TEMP GAIN R Reset  | Execute        | BE EF         | 03    | 06 00 | 10 C6 | 06 00        | 46 70 | 00 00        |       |

(continued on next page)

RS-232C Communication / Network command table (continued)

| Names                     | Operation Type | Header |       |       |       | Command Data |       |              |       |
|---------------------------|----------------|--------|-------|-------|-------|--------------|-------|--------------|-------|
|                           |                |        |       |       | CRC   | Action       | Type  | Setting Code |       |
| COLOR TEMP GAIN G         | Get            | BE EF  | 03    | 06 00 | 70 F4 | 02 00        | B2 30 | 00 00        |       |
|                           | Increment      | BE EF  | 03    | 06 00 | 16 F4 | 04 00        | B2 30 | 00 00        |       |
|                           | Decrement      | BE EF  | 03    | 06 00 | C7 F5 | 05 00        | B2 30 | 00 00        |       |
| COLOR TEMP GAIN G Reset   | Execute        | BE EF  | 03    | 06 00 | EC C7 | 06 00        | 47 70 | 00 00        |       |
| COLOR TEMP GAIN B         | Get            | BE EF  | 03    | 06 00 | 8C F5 | 02 00        | B3 30 | 00 00        |       |
|                           | Increment      | BE EF  | 03    | 06 00 | EA F5 | 04 00        | B3 30 | 00 00        |       |
|                           | Decrement      | BE EF  | 03    | 06 00 | 3B F4 | 05 00        | B3 30 | 00 00        |       |
| COLOR TEMP GAIN B Reset   | Execute        | BE EF  | 03    | 06 00 | F8 C4 | 06 00        | 48 70 | 00 00        |       |
| COLOR TEMP OFFSET R       | Get            | BE EF  | 03    | 06 00 | 04 F5 | 02 00        | B5 30 | 00 00        |       |
|                           | Increment      | BE EF  | 03    | 06 00 | 62 F5 | 04 00        | B5 30 | 00 00        |       |
|                           | Decrement      | BE EF  | 03    | 06 00 | B3 F4 | 05 00        | B5 30 | 00 00        |       |
| COLOR TEMP OFFSET R Reset | Execute        | BE EF  | 03    | 06 00 | 40 C5 | 06 00        | 4A 70 | 00 00        |       |
| COLOR TEMP OFFSET G       | Get            | BE EF  | 03    | 06 00 | 40 F5 | 02 00        | B6 30 | 00 00        |       |
|                           | Increment      | BE EF  | 03    | 06 00 | 26 F5 | 04 00        | B6 30 | 00 00        |       |
|                           | Decrement      | BE EF  | 03    | 06 00 | F7 F4 | 05 00        | B6 30 | 00 00        |       |
| COLOR TEMP OFFSET G Reset | Execute        | BE EF  | 03    | 06 00 | BC C4 | 06 00        | 4B 70 | 00 00        |       |
| COLOR TEMP OFFSET B       | Get            | BE EF  | 03    | 06 00 | BC F4 | 02 00        | B7 30 | 00 00        |       |
|                           | Increment      | BE EF  | 03    | 06 00 | DA F4 | 04 00        | B7 30 | 00 00        |       |
|                           | Decrement      | BE EF  | 03    | 06 00 | 0B F5 | 05 00        | B7 30 | 00 00        |       |
| COLOR TEMP OFFSET B Reset | Execute        | BE EF  | 03    | 06 00 | C8 C5 | 06 00        | 4C 70 | 00 00        |       |
| COLOR                     | Get            | BE EF  | 03    | 06 00 | B5 72 | 02 00        | 02 22 | 00 00        |       |
|                           | Increment      | BE EF  | 03    | 06 00 | D3 72 | 04 00        | 02 22 | 00 00        |       |
|                           | Decrement      | BE EF  | 03    | 06 00 | 02 73 | 05 00        | 02 22 | 00 00        |       |
| COLOR Reset               | Execute        | BE EF  | 03    | 06 00 | 80 D0 | 06 00        | 0A 70 | 00 00        |       |
| TINT                      | Get            | BE EF  | 03    | 06 00 | 49 73 | 02 00        | 03 22 | 00 00        |       |
|                           | Increment      | BE EF  | 03    | 06 00 | 2F 73 | 04 00        | 03 22 | 00 00        |       |
|                           | Decrement      | BE EF  | 03    | 06 00 | FE 72 | 05 00        | 03 22 | 00 00        |       |
| TINT Reset                | Execute        | BE EF  | 03    | 06 00 | 7C D1 | 06 00        | 0B 70 | 00 00        |       |
| SHARPNESS                 | Get            | BE EF  | 03    | 06 00 | F1 72 | 02 00        | 01 22 | 00 00        |       |
|                           | Increment      | BE EF  | 03    | 06 00 | 97 72 | 04 00        | 01 22 | 00 00        |       |
|                           | Decrement      | BE EF  | 03    | 06 00 | 46 73 | 05 00        | 01 22 | 00 00        |       |
| SHARPNESS Reset           | Execute        | BE EF  | 03    | 06 00 | C4 D0 | 06 00        | 09 70 | 00 00        |       |
| ACTIVE IRIS               | Set            | OFF    | BE EF | 03    | 06 00 | 0B 22        | 01 00 | 04 33        | 00 00 |
|                           |                | ON     | BE EF | 03    | 06 00 | 5B 2E        | 01 00 | 04 33        | 11 00 |
|                           | Get            | BE EF  | 03    | 06 00 | 38 22 | 02 00        | 04 33 | 00 00        |       |
| MY MEMORY Load            | Set            | 1      | BE EF | 03    | 06 00 | 0E D7        | 01 00 | 14 20        | 00 00 |
|                           |                | 2      | BE EF | 03    | 06 00 | 9E D6        | 01 00 | 14 20        | 01 00 |
|                           |                | 3      | BE EF | 03    | 06 00 | 6E D6        | 01 00 | 14 20        | 02 00 |
|                           |                | 4      | BE EF | 03    | 06 00 | FE D7        | 01 00 | 14 20        | 03 00 |
| MY MEMORY Save            | Set            | 1      | BE EF | 03    | 06 00 | F2 D6        | 01 00 | 15 20        | 00 00 |
|                           |                | 2      | BE EF | 03    | 06 00 | 62 D7        | 01 00 | 15 20        | 01 00 |
|                           |                | 3      | BE EF | 03    | 06 00 | 92 D7        | 01 00 | 15 20        | 02 00 |
|                           |                | 4      | BE EF | 03    | 06 00 | 02 D6        | 01 00 | 15 20        | 03 00 |

(continued on next page)

## RS-232C Communication / Network command table (continued)

| Names               | Operation Type | Header    |        |       |              |       | Command Data |       |       |
|---------------------|----------------|-----------|--------|-------|--------------|-------|--------------|-------|-------|
|                     |                | CRC       | Action | Type  | Setting Code |       |              |       |       |
| ASPECT              | Set            | 4:3       | BE EF  | 03    | 06 00        | 9E D0 | 01 00        | 08 20 | 00 00 |
|                     |                | 16:9      | BE EF  | 03    | 06 00        | 0E D1 | 01 00        | 08 20 | 01 00 |
|                     |                | 14:9      | BE EF  | 03    | 06 00        | CE D6 | 01 00        | 08 20 | 09 00 |
|                     |                | 16:10     | BE EF  | 03    | 06 00        | 3E D6 | 01 00        | 08 20 | 0A 00 |
|                     |                | NORMAL    | BE EF  | 03    | 06 00        | 5E DD | 01 00        | 08 20 | 10 00 |
|                     |                | NATIVE(*) | BE EF  | 03    | 06 00        | 5E D7 | 01 00        | 08 20 | 08 00 |
|                     |                | ZOOM      | BE EF  | 03    | 06 00        | 9E C4 | 01 00        | 08 20 | 30 00 |
|                     | Get            | BE EF     | 03     | 06 00 | AD D0        | 02 00 | 08 20        | 00 00 |       |
| OVER SCAN           | Get            | BE EF     | 03     | 06 00 | 91 70        | 02 00 | 09 22        | 00 00 |       |
|                     | Increment      | BE EF     | 03     | 06 00 | F7 70        | 04 00 | 09 22        | 00 00 |       |
|                     | Decrement      | BE EF     | 03     | 06 00 | 26 71        | 05 00 | 09 22        | 00 00 |       |
| OVER SCAN Reset     | Execute        | BE EF     | 03     | 06 00 | EC D9        | 06 00 | 27 70        | 00 00 |       |
| V POSITION          | Get            | BE EF     | 03     | 06 00 | 0D 83        | 02 00 | 00 21        | 00 00 |       |
|                     | Increment      | BE EF     | 03     | 06 00 | 6B 83        | 04 00 | 00 21        | 00 00 |       |
|                     | Decrement      | BE EF     | 03     | 06 00 | BA 82        | 05 00 | 00 21        | 00 00 |       |
| V POSITION Reset    | Execute        | BE EF     | 03     | 06 00 | E0 D2        | 06 00 | 02 70        | 00 00 |       |
| H POSITION          | Get            | BE EF     | 03     | 06 00 | F1 82        | 02 00 | 01 21        | 00 00 |       |
|                     | Increment      | BE EF     | 03     | 06 00 | 97 82        | 04 00 | 01 21        | 00 00 |       |
|                     | Decrement      | BE EF     | 03     | 06 00 | 46 83        | 05 00 | 01 21        | 00 00 |       |
| H POSITION Reset    | Execute        | BE EF     | 03     | 06 00 | 1C D3        | 06 00 | 03 70        | 00 00 |       |
| H PHASE             | Get            | BE EF     | 03     | 06 00 | 49 83        | 02 00 | 03 21        | 00 00 |       |
|                     | Increment      | BE EF     | 03     | 06 00 | 2F 83        | 04 00 | 03 21        | 00 00 |       |
|                     | Decrement      | BE EF     | 03     | 06 00 | FE 82        | 05 00 | 03 21        | 00 00 |       |
| H SIZE              | Get            | BE EF     | 03     | 06 00 | B5 82        | 02 00 | 02 21        | 00 00 |       |
|                     | Increment      | BE EF     | 03     | 06 00 | D3 82        | 04 00 | 02 21        | 00 00 |       |
|                     | Decrement      | BE EF     | 03     | 06 00 | 02 83        | 05 00 | 02 21        | 00 00 |       |
| H SIZE Reset        | Execute        | BE EF     | 03     | 06 00 | 68 D2        | 06 00 | 04 70        | 00 00 |       |
| AUTO ADJUST EXECUTE | Execute        | BE EF     | 03     | 06 00 | 91 D0        | 06 00 | 0A 20        | 00 00 |       |
| PROGRESSIVE         | Set            | OFF       | BE EF  | 03    | 06 00        | 4A 72 | 01 00        | 07 22 | 00 00 |
|                     |                | TV        | BE EF  | 03    | 06 00        | DA 73 | 01 00        | 07 22 | 01 00 |
|                     |                | FILM      | BE EF  | 03    | 06 00        | 2A 73 | 01 00        | 07 22 | 02 00 |
|                     | Get            | BE EF     | 03     | 06 00 | 79 72        | 02 00 | 07 22        | 00 00 |       |
| VIDEO NR            | Set            | LOW       | BE EF  | 03    | 06 00        | 26 72 | 01 00        | 06 22 | 01 00 |
|                     |                | MID       | BE EF  | 03    | 06 00        | D6 72 | 01 00        | 06 22 | 02 00 |
|                     |                | HIGH      | BE EF  | 03    | 06 00        | 46 73 | 01 00        | 06 22 | 03 00 |
|                     | Get            | BE EF     | 03     | 06 00 | 85 73        | 02 00 | 06 22        | 00 00 |       |
| COLOR SPACE         | Set            | AUTO      | BE EF  | 03    | 06 00        | 0E 72 | 01 00        | 04 22 | 00 00 |
|                     |                | RGB       | BE EF  | 03    | 06 00        | 9E 73 | 01 00        | 04 22 | 01 00 |
|                     |                | SMPTE240  | BE EF  | 03    | 06 00        | 6E 73 | 01 00        | 04 22 | 02 00 |
|                     |                | REC709    | BE EF  | 03    | 06 00        | FE 72 | 01 00        | 04 22 | 03 00 |
|                     |                | REC601    | BE EF  | 03    | 06 00        | CE 70 | 01 00        | 04 22 | 04 00 |
|                     | Get            | BE EF     | 03     | 06 00 | 3D 72        | 02 00 | 04 22        | 00 00 |       |

(\*) Only for [WXGA Model]

(continued on next page)

## RS-232C Communication / Network command table (continued)

| Names                        | Operation Type | Header        |       |       |       | Command Data |       |              |       |
|------------------------------|----------------|---------------|-------|-------|-------|--------------|-------|--------------|-------|
|                              |                |               |       |       | CRC   | Action       | Type  | Setting Code |       |
| C-VIDEO FORMAT               | Set            | AUTO          | BE EF | 03    | 06 00 | A2 70        | 01 00 | 11 22        | 0A 00 |
|                              |                | NTSC          | BE EF | 03    | 06 00 | C2 74        | 01 00 | 11 22        | 04 00 |
|                              |                | PAL           | BE EF | 03    | 06 00 | 52 75        | 01 00 | 11 22        | 05 00 |
|                              |                | SECAM         | BE EF | 03    | 06 00 | 52 70        | 01 00 | 11 22        | 09 00 |
|                              |                | NTSC4.43      | BE EF | 03    | 06 00 | 62 77        | 01 00 | 11 22        | 02 00 |
|                              |                | M-PAL         | BE EF | 03    | 06 00 | C2 71        | 01 00 | 11 22        | 08 00 |
|                              | N-PAL          | BE EF         | 03    | 06 00 | 32 74 | 01 00        | 11 22 | 07 00        |       |
|                              | Get            | BE EF         | 03    | 06 00 | 31 76 | 02 00        | 11 22 | 00 00        |       |
| HDMI1 RANGE                  | Set            | AUTO          | BE EF | 03    | 06 00 | 86 D8        | 01 00 | 22 20        | 00 00 |
|                              |                | NORMAL        | BE EF | 03    | 06 00 | 16 D9        | 01 00 | 22 20        | 01 00 |
|                              | ENHANCED       | BE EF         | 03    | 06 00 | E6 D9 | 01 00        | 22 20 | 02 00        |       |
|                              | Get            | BE EF         | 03    | 06 00 | B5 D8 | 02 00        | 22 20 | 00 00        |       |
| HDMI2/MHL RANGE              | Set            | AUTO          | BE EF | 03    | 06 00 | 7A D9        | 01 00 | 23 20        | 00 00 |
|                              |                | NORMAL        | BE EF | 03    | 06 00 | EA D8        | 01 00 | 23 20        | 01 00 |
|                              | ENHANCED       | BE EF         | 03    | 06 00 | 1A D8 | 01 00        | 23 20 | 02 00        |       |
|                              | Get            | BE EF         | 03    | 06 00 | 49 D9 | 02 00        | 23 20 | 00 00        |       |
| COMPUTER IN1                 | Set            | AUTO          | BE EF | 03    | 06 00 | CE D6        | 01 00 | 10 20        | 03 00 |
|                              |                | SYNC ON G OFF | BE EF | 03    | 06 00 | 5E D7        | 01 00 | 10 20        | 02 00 |
|                              | Get            | BE EF         | 03    | 06 00 | 0D D6 | 02 00        | 10 20 | 00 00        |       |
| COMPUTER IN2                 | Set            | AUTO          | BE EF | 03    | 06 00 | 32 D7        | 01 00 | 11 20        | 03 00 |
|                              |                | SYNC ON G OFF | BE EF | 03    | 06 00 | A2 D6        | 01 00 | 11 20        | 02 00 |
|                              | MONITOR OUT    | BE EF         | 03    | 06 00 | 02 D0 | 01 00        | 11 20 | 08 00        |       |
|                              | Get            | BE EF         | 03    | 06 00 | F1 D7 | 02 00        | 11 20 | 00 00        |       |
| FRAME LOCK –<br>COMPUTER IN1 | Set            | OFF           | BE EF | 03    | 06 00 | 3B C2        | 01 00 | 50 30        | 00 00 |
|                              |                | ON            | BE EF | 03    | 06 00 | AB C3        | 01 00 | 50 30        | 01 00 |
|                              | Get            | BE EF         | 03    | 06 00 | 08 C2 | 02 00        | 50 30 | 00 00        |       |
| FRAME LOCK –<br>COMPUTER IN2 | Set            | OFF           | BE EF | 03    | 06 00 | 0B C3        | 01 00 | 54 30        | 00 00 |
|                              |                | ON            | BE EF | 03    | 06 00 | 9B C2        | 01 00 | 54 30        | 01 00 |
|                              | Get            | BE EF         | 03    | 06 00 | 38 C3 | 02 00        | 54 30 | 00 00        |       |
| FRAME LOCK –<br>HDMI1        | Set            | OFF           | BE EF | 03    | 06 00 | 7F C2        | 01 00 | 53 30        | 00 00 |
|                              |                | ON            | BE EF | 03    | 06 00 | EF C3        | 01 00 | 53 30        | 01 00 |
|                              | Get            | BE EF         | 03    | 06 00 | 4C C2 | 02 00        | 53 30 | 00 00        |       |
| FRAME LOCK -<br>HDMI2/MHL    | Set            | OFF           | BE EF | 03    | 06 00 | 97 C0        | 01 00 | 5D 30        | 00 00 |
|                              |                | ON            | BE EF | 03    | 06 00 | 07 C1        | 01 00 | 5D 30        | 01 00 |
|                              | Get            | BE EF         | 03    | 06 00 | A4 C0 | 02 00        | 5D 30 | 00 00        |       |
| MHL STANDBY<br>POWER         | Set            | OFF           | BE EF | 03    | 06 00 | FE 2D        | 01 00 | 30 23        | 00 00 |
|                              |                | ON            | BE EF | 03    | 06 00 | 6E 2C        | 01 00 | 30 23        | 01 00 |
|                              | Get            | BE EF         | 03    | 06 00 | CD 2D | 02 00        | 30 23 | 00 00        |       |
| AUTO KEYSTONE<br>EXECUTE     | Execute        | BE EF         | 03    | 06 00 | E5 D1 | 06 00        | 0D 20 | 00 00        |       |
| KEYSTONE V                   | Get            | BE EF         | 03    | 06 00 | B9 D3 | 02 00        | 07 20 | 00 00        |       |
|                              | Increment      | BE EF         | 03    | 06 00 | DF D3 | 04 00        | 07 20 | 00 00        |       |
|                              | Decrement      | BE EF         | 03    | 06 00 | 0E D2 | 05 00        | 07 20 | 00 00        |       |
| KEYSTONE V Reset             | Execute        | BE EF         | 03    | 06 00 | 08 D0 | 06 00        | 0C 70 | 00 00        |       |
| KEYSTONE H                   | Get            | BE EF         | 03    | 06 00 | E9 D0 | 02 00        | 0B 20 | 00 00        |       |
|                              | Increment      | BE EF         | 03    | 06 00 | 8F D0 | 04 00        | 0B 20 | 00 00        |       |
|                              | Decrement      | BE EF         | 03    | 06 00 | 5E D1 | 05 00        | 0B 20 | 00 00        |       |
| KEYSTONE H Reset             | Execute        | BE EF         | 03    | 06 00 | 98 D8 | 06 00        | 20 70 | 00 00        |       |

(continued on next page)



RS-232C Communication / Network command table (continued)

| Names                              | Operation Type | Header  |       |       |       | Command Data |        |       |              |
|------------------------------------|----------------|---------|-------|-------|-------|--------------|--------|-------|--------------|
|                                    |                |         |       |       |       | CRC          | Action | Type  | Setting Code |
| PERFECT FIT                        | Set            | Disable | BE EF | 03    | 06 00 | FE 88        | 01 00  | 20 21 | 00 00        |
|                                    |                | Enable  | BE EF | 03    | 06 00 | 6E 89        | 01 00  | 20 21 | 01 00        |
|                                    | Get            | BE EF   | 03    | 06 00 | CD 88 | 02 00        | 20 21  | 00 00 |              |
| PERFECT FIT Left TOP -H            | Get            | BE EF   | 03    | 06 00 | 31 89 | 02 00        | 21 21  | 00 00 |              |
|                                    | Increment      | BE EF   | 03    | 06 00 | 57 89 | 04 00        | 21 21  | 00 00 |              |
|                                    | Decrement      | BE EF   | 03    | 06 00 | 86 88 | 05 00        | 21 21  | 00 00 |              |
| PERFECT FIT Left TOP -V            | Get            | BE EF   | 03    | 06 00 | 75 89 | 02 00        | 22 21  | 00 00 |              |
|                                    | Increment      | BE EF   | 03    | 06 00 | 13 89 | 04 00        | 22 21  | 00 00 |              |
|                                    | Decrement      | BE EF   | 03    | 06 00 | C2 88 | 05 00        | 22 21  | 00 00 |              |
| PERFECT FIT Right Top -H           | Get            | BE EF   | 03    | 06 00 | 89 88 | 02 00        | 23 21  | 00 00 |              |
|                                    | Increment      | BE EF   | 03    | 06 00 | EF 88 | 04 00        | 23 21  | 00 00 |              |
|                                    | Decrement      | BE EF   | 03    | 06 00 | 3E 89 | 05 00        | 23 21  | 00 00 |              |
| PERFECT FIT Right Top -V           | Get            | BE EF   | 03    | 06 00 | FD 89 | 02 00        | 24 21  | 00 00 |              |
|                                    | Increment      | BE EF   | 03    | 06 00 | 9B 89 | 04 00        | 24 21  | 00 00 |              |
|                                    | Decrement      | BE EF   | 03    | 06 00 | 4A 88 | 05 00        | 24 21  | 00 00 |              |
| PERFECT FIT Left Bottom -H         | Get            | BE EF   | 03    | 06 00 | 01 88 | 02 00        | 25 21  | 00 00 |              |
|                                    | Increment      | BE EF   | 03    | 06 00 | 67 88 | 04 00        | 25 21  | 00 00 |              |
|                                    | Decrement      | BE EF   | 03    | 06 00 | B6 89 | 05 00        | 25 21  | 00 00 |              |
| PERFECT FIT Left Bottom -V         | Get            | BE EF   | 03    | 06 00 | 45 88 | 02 00        | 26 21  | 00 00 |              |
|                                    | Increment      | BE EF   | 03    | 06 00 | 23 88 | 04 00        | 26 21  | 00 00 |              |
|                                    | Decrement      | BE EF   | 03    | 06 00 | F2 89 | 05 00        | 26 21  | 00 00 |              |
| PERFECT FIT Right Bottom -H        | Get            | BE EF   | 03    | 06 00 | B9 89 | 02 00        | 27 21  | 00 00 |              |
|                                    | Increment      | BE EF   | 03    | 06 00 | DF 89 | 04 00        | 27 21  | 00 00 |              |
|                                    | Decrement      | BE EF   | 03    | 06 00 | 0E 88 | 05 00        | 27 21  | 00 00 |              |
| PERFECT FIT Right Bottom -V        | Get            | BE EF   | 03    | 06 00 | AD 8A | 02 00        | 28 21  | 00 00 |              |
|                                    | Increment      | BE EF   | 03    | 06 00 | CB 8A | 04 00        | 28 21  | 00 00 |              |
|                                    | Decrement      | BE EF   | 03    | 06 00 | 1A 8B | 05 00        | 28 21  | 00 00 |              |
| PERFECT FIT Reset                  | Execute        | BE EF   | 03    | 06 00 | D5 8A | 06 00        | 29 21  | 00 00 |              |
| PERFECT FIT Left Side Distortion   | Get            | BE EF   | 03    | 06 00 | 31 97 | 02 00        | 41 21  | 00 00 |              |
|                                    | Increment      | BE EF   | 03    | 06 00 | 57 97 | 04 00        | 41 21  | 00 00 |              |
|                                    | Decrement      | BE EF   | 03    | 06 00 | 86 96 | 05 00        | 41 21  | 00 00 |              |
| PERFECT FIT Right Side Distortion  | Get            | BE EF   | 03    | 06 00 | 75 97 | 02 00        | 42 21  | 00 00 |              |
|                                    | Increment      | BE EF   | 03    | 06 00 | 13 97 | 04 00        | 42 21  | 00 00 |              |
|                                    | Decrement      | BE EF   | 03    | 06 00 | C2 96 | 05 00        | 42 21  | 00 00 |              |
| PERFECT FIT Distortion Position V  | Get            | BE EF   | 03    | 06 00 | 89 96 | 02 00        | 43 21  | 00 00 |              |
|                                    | Increment      | BE EF   | 03    | 06 00 | EF 96 | 04 00        | 43 21  | 00 00 |              |
|                                    | Decrement      | BE EF   | 03    | 06 00 | 3E 97 | 05 00        | 43 21  | 00 00 |              |
| PERFECT FIT Top Side Distortion    | Get            | BE EF   | 03    | 06 00 | FD 97 | 02 00        | 44 21  | 00 00 |              |
|                                    | Increment      | BE EF   | 03    | 06 00 | 9B 97 | 04 00        | 44 21  | 00 00 |              |
|                                    | Decrement      | BE EF   | 03    | 06 00 | 4A 96 | 05 00        | 44 21  | 00 00 |              |
| PERFECT FIT Bottom Side Distortion | Get            | BE EF   | 03    | 06 00 | 01 96 | 02 00        | 45 21  | 00 00 |              |
|                                    | Increment      | BE EF   | 03    | 06 00 | 67 96 | 04 00        | 45 21  | 00 00 |              |
|                                    | Decrement      | BE EF   | 03    | 06 00 | B6 97 | 05 00        | 45 21  | 00 00 |              |
| PERFECT FIT Distortion Position H  | Get            | BE EF   | 03    | 06 00 | 45 96 | 02 00        | 46 21  | 00 00 |              |
|                                    | Increment      | BE EF   | 03    | 06 00 | 23 96 | 04 00        | 46 21  | 00 00 |              |
|                                    | Decrement      | BE EF   | 03    | 06 00 | F2 97 | 05 00        | 46 21  | 00 00 |              |
| PERFECT FIT All Sides Reset        | Execute        | BE EF   | 03    | 06 00 | 3D 96 | 06 00        | 47 21  | 00 00 |              |

(continued on next page)



RS-232C Communication / Network command table (continued)

| Names                     | Operation Type | Header          |       |       |       | Command Data |        |       |              |
|---------------------------|----------------|-----------------|-------|-------|-------|--------------|--------|-------|--------------|
|                           |                |                 |       |       |       | CRC          | Action | Type  | Setting Code |
| PERFECT FIT Memory Save-1 | Execute        | BE EF           | 03    | 06 00 | 29 95 | 06 00        | 48 21  | 00 00 |              |
| PERFECT FIT Memory Save-2 | Execute        | BE EF           | 03    | 06 00 | D5 94 | 06 00        | 49 21  | 00 00 |              |
| PERFECT FIT Memory Save-3 | Execute        | BE EF           | 03    | 06 00 | 91 94 | 06 00        | 4A 21  | 00 00 |              |
| PERFECT FIT Memory Load-1 | Execute        | BE EF           | 03    | 06 00 | 6D 95 | 06 00        | 4B 21  | 00 00 |              |
| PERFECT FIT Memory Load-2 | Execute        | BE EF           | 03    | 06 00 | 19 94 | 06 00        | 4C 21  | 00 00 |              |
| PERFECT FIT Memory Load-3 | Execute        | BE EF           | 03    | 06 00 | E5 95 | 06 00        | 4D 21  | 00 00 |              |
| ECO MODE                  | Set            | NORMAL          | BE EF | 03    | 06 00 | 3B 23        | 01 00  | 00 33 | 00 00        |
|                           |                | ECO             | BE EF | 03    | 06 00 | AB 22        | 01 00  | 00 33 | 01 00        |
|                           | Get            | BE EF           | 03    | 06 00 | 08 23 | 02 00        | 00 33  | 00 00 |              |
| INSTALLATION              | Set            | FRONT / DESKTOP | BE EF | 03    | 06 00 | C7 D2        | 01 00  | 01 30 | 00 00        |
|                           |                | REAR / DESKTOP  | BE EF | 03    | 06 00 | 57 D3        | 01 00  | 01 30 | 01 00        |
|                           |                | REAR / CEILING  | BE EF | 03    | 06 00 | A7 D3        | 01 00  | 01 30 | 02 00        |
|                           |                | FRONT / CEILING | BE EF | 03    | 06 00 | 37 D2        | 01 00  | 01 30 | 03 00        |
|                           | Get            | BE EF           | 03    | 06 00 | F4 D2 | 02 00        | 01 30  | 00 00 |              |
| STANDBY MODE              | Set            | NORMAL          | BE EF | 03    | 06 00 | D6 D2        | 01 00  | 01 60 | 00 00        |
|                           |                | SAVING          | BE EF | 03    | 06 00 | 46 D3        | 01 00  | 01 60 | 01 00        |
|                           |                | NETWORK (WOL)   | BE EF | 03    | 06 00 | B6 D3        | 01 00  | 01 60 | 02 00        |
|                           | Get            | BE EF           | 03    | 06 00 | E5 D2 | 02 00        | 01 60  | 00 00 |              |
| AUTO KEYSTONE V           | Set            | OFF             | BE EF | 03    | 06 00 | EA D1        | 01 00  | 0F 20 | 00 00        |
|                           |                | ON              | BE EF | 03    | 06 00 | 7A D0        | 01 00  | 0F 20 | 01 00        |
|                           | Get            | BE EF           | 03    | 06 00 | D9 D1 | 02 00        | 0F 20  | 00 00 |              |
| IMAGE OPTIMIZER           | Set            | OFF             | BE EF | 03    | 06 00 | D6 71        | 01 00  | 0E 22 | 00 00        |
|                           |                | ON              | BE EF | 03    | 06 00 | 46 70        | 01 00  | 0E 22 | 01 00        |
|                           | Get            | BE EF           | 03    | 06 00 | E5 71 | 02 00        | 0E 22  | 00 00 |              |
| AV MUTE                   | Set            | OFF             | BE EF | 03    | 06 00 | FE F0        | 01 00  | A0 20 | 00 00        |
|                           |                | ON              | BE EF | 03    | 06 00 | 6E F1        | 01 00  | A0 20 | 01 00        |
|                           | Get            | BE EF           | 03    | 06 00 | CD F0 | 02 00        | A0 20  | 00 00 |              |
| VOLUME - COMPUTER IN1     | Get            | BE EF           | 03    | 06 00 | CD CC | 02 00        | 60 20  | 00 00 |              |
|                           | Increment      | BE EF           | 03    | 06 00 | AB CC | 04 00        | 60 20  | 00 00 |              |
|                           | Decrement      | BE EF           | 03    | 06 00 | 7A CD | 05 00        | 60 20  | 00 00 |              |
| VOLUME - COMPUTER IN2     | Get            | BE EF           | 03    | 06 00 | FD CD | 02 00        | 64 20  | 00 00 |              |
|                           | Increment      | BE EF           | 03    | 06 00 | 9B CD | 04 00        | 64 20  | 00 00 |              |
|                           | Decrement      | BE EF           | 03    | 06 00 | 4A CC | 05 00        | 64 20  | 00 00 |              |
| VOLUME - VIDEO            | Get            | BE EF           | 03    | 06 00 | 31 CD | 02 00        | 61 20  | 00 00 |              |
|                           | Increment      | BE EF           | 03    | 06 00 | 57 CD | 04 00        | 61 20  | 00 00 |              |
|                           | Decrement      | BE EF           | 03    | 06 00 | 86 CC | 05 00        | 61 20  | 00 00 |              |
| VOLUME - HDMI1            | Get            | BE EF           | 03    | 06 00 | 89 CC | 02 00        | 63 20  | 00 00 |              |
|                           | Increment      | BE EF           | 03    | 06 00 | EF CC | 04 00        | 63 20  | 00 00 |              |
|                           | Decrement      | BE EF           | 03    | 06 00 | 3E CD | 05 00        | 63 20  | 00 00 |              |

(continued on next page)

RS-232C Communication / Network command table (continued)

| Names                       | Operation Type | Header          |        |       |              | Command Data |       |       |       |
|-----------------------------|----------------|-----------------|--------|-------|--------------|--------------|-------|-------|-------|
|                             |                | CRC             | Action | Type  | Setting Code |              |       |       |       |
| VOLUME - HDMI2/MHL          | Get            | BE EF           | 03     | 06 00 | 61 CE        | 02 00        | 6D 20 | 00 00 |       |
|                             | Increment      | BE EF           | 03     | 06 00 | 07 CE        | 04 00        | 6D 20 | 00 00 |       |
|                             | Decrement      | BE EF           | 03     | 06 00 | D6 CF        | 05 00        | 6D 20 | 00 00 |       |
| VOLUME - LAN                | Get            | BE EF           | 03     | 06 00 | E9 CE        | 02 00        | 6B 20 | 00 00 |       |
|                             | Increment      | BE EF           | 03     | 06 00 | 8F CE        | 04 00        | 6B 20 | 00 00 |       |
|                             | Decrement      | BE EF           | 03     | 06 00 | 5E CF        | 05 00        | 6B 20 | 00 00 |       |
| VOLUME - USB TYPE A         | Get            | BE EF           | 03     | 06 00 | 45 CC        | 02 00        | 66 20 | 00 00 |       |
|                             | Increment      | BE EF           | 03     | 06 00 | 23 CC        | 04 00        | 66 20 | 00 00 |       |
|                             | Decrement      | BE EF           | 03     | 06 00 | F2 CD        | 05 00        | 66 20 | 00 00 |       |
| VOLUME - USB TYPE B         | Get            | BE EF           | 03     | 06 00 | 9D CF        | 02 00        | 6C 20 | 00 00 |       |
|                             | Increment      | BE EF           | 03     | 06 00 | FB CF        | 04 00        | 6C 20 | 00 00 |       |
|                             | Decrement      | BE EF           | 03     | 06 00 | 2A CE        | 05 00        | 6C 20 | 00 00 |       |
| VOLUME - STANDBY            | Get            | BE EF           | 03     | 06 00 | D9 CF        | 02 00        | 6F 20 | 00 00 |       |
|                             | Increment      | BE EF           | 03     | 06 00 | BF CF        | 04 00        | 6F 20 | 00 00 |       |
|                             | Decrement      | BE EF           | 03     | 06 00 | 6E CE        | 05 00        | 6F 20 | 00 00 |       |
| VOLUME - ALL                | Get            | BE EF           | 03     | 06 00 | CD C3        | 02 00        | 50 20 | 00 00 |       |
|                             | Increment      | BE EF           | 03     | 06 00 | AB C3        | 04 00        | 50 20 | 00 00 |       |
|                             | Decrement      | BE EF           | 03     | 06 00 | 7A C2        | 05 00        | 50 20 | 00 00 |       |
| MUTE                        | Set            | OFF             | BE EF  | 03    | 06 00        | 46 D3        | 01 00 | 02 20 | 00 00 |
|                             |                | ON              | BE EF  | 03    | 06 00        | D6 D2        | 01 00 | 02 20 | 01 00 |
|                             | Get            | BE EF           | 03     | 06 00 | 75 D3        | 02 00        | 02 20 | 00 00 |       |
| SPEAKER                     | Set            | OFF             | BE EF  | 03    | 06 00        | 6E D5        | 01 00 | 1C 20 | 00 00 |
|                             |                | ON              | BE EF  | 03    | 06 00        | FE D4        | 01 00 | 1C 20 | 01 00 |
|                             | Get            | BE EF           | 03     | 06 00 | 5D D5        | 02 00        | 1C 20 | 00 00 |       |
| AUDIO SOURCE - COMPUTER IN1 | Set            | OFF             | BE EF  | 03    | 06 00        | FE DD        | 01 00 | 30 20 | 00 00 |
|                             |                | AUDIO IN1       | BE EF  | 03    | 06 00        | 6E DC        | 01 00 | 30 20 | 01 00 |
|                             |                | AUDIO IN2       | BE EF  | 03    | 06 00        | 9E DC        | 01 00 | 30 20 | 02 00 |
|                             |                | AUDIO IN3       | BE EF  | 03    | 06 00        | 0E DD        | 01 00 | 30 20 | 03 00 |
|                             | Get            | BE EF           | 03     | 06 00 | CD DD        | 02 00        | 30 20 | 00 00 |       |
| AUDIO SOURCE - COMPUTER IN2 | Set            | OFF             | BE EF  | 03    | 06 00        | CE DC        | 01 00 | 34 20 | 00 00 |
|                             |                | AUDIO IN1       | BE EF  | 03    | 06 00        | 5E DD        | 01 00 | 34 20 | 01 00 |
|                             |                | AUDIO IN2       | BE EF  | 03    | 06 00        | AE DD        | 01 00 | 34 20 | 02 00 |
|                             |                | AUDIO IN3       | BE EF  | 03    | 06 00        | 3E DC        | 01 00 | 34 20 | 03 00 |
|                             | Get            | BE EF           | 03     | 06 00 | FD DC        | 02 00        | 34 20 | 00 00 |       |
| AUDIO SOURCE - HDMI1        | Set            | OFF             | BE EF  | 03    | 06 00        | BA DD        | 01 00 | 33 20 | 00 00 |
|                             |                | AUDIO IN1       | BE EF  | 03    | 06 00        | 2A DC        | 01 00 | 33 20 | 01 00 |
|                             |                | AUDIO IN2       | BE EF  | 03    | 06 00        | DA DC        | 01 00 | 33 20 | 02 00 |
|                             |                | AUDIO IN3       | BE EF  | 03    | 06 00        | 4A DD        | 01 00 | 33 20 | 03 00 |
|                             |                | AUDIO_HDMI1     | BE EF  | 03    | 06 00        | 7A C4        | 01 00 | 33 20 | 20 00 |
|                             | Get            | BE EF           | 03     | 06 00 | 89 DD        | 02 00        | 33 20 | 00 00 |       |
| AUDIO SOURCE - HDMI2/MHL    | Set            | OFF             | BE EF  | 03    | 06 00        | 52 DF        | 01 00 | 3D 20 | 00 00 |
|                             |                | AUDIO IN1       | BE EF  | 03    | 06 00        | C2 DE        | 01 00 | 3D 20 | 01 00 |
|                             |                | AUDIO IN2       | BE EF  | 03    | 06 00        | 32 DE        | 01 00 | 3D 20 | 02 00 |
|                             |                | AUDIO IN3       | BE EF  | 03    | 06 00        | A2 DF        | 01 00 | 3D 20 | 03 00 |
|                             |                | AUDIO_HDMI2/MHL | BE EF  | 03    | 06 00        | 02 C7        | 01 00 | 3D 20 | 21 00 |
|                             | Get            | BE EF           | 03     | 06 00 | 61 DF        | 02 00        | 3D 20 | 00 00 |       |

(continued on next page)

## RS-232C Communication / Network command table (continued)

| Names                     | Operation Type   | Header    |       |       |       | Command Data |        |       |              |
|---------------------------|------------------|-----------|-------|-------|-------|--------------|--------|-------|--------------|
|                           |                  |           |       |       |       | CRC          | Action | Type  | Setting Code |
| AUDIO SOURCE - VIDEO      | Set              | OFF       | BE EF | 03    | 06 00 | 02 DC        | 01 00  | 31 20 | 00 00        |
|                           |                  | AUDIO IN1 | BE EF | 03    | 06 00 | 92 DD        | 01 00  | 31 20 | 01 00        |
|                           |                  | AUDIO IN2 | BE EF | 03    | 06 00 | 62 DD        | 01 00  | 31 20 | 02 00        |
|                           |                  | AUDIO IN3 | BE EF | 03    | 06 00 | F2 DC        | 01 00  | 31 20 | 03 00        |
|                           | Get              | BE EF     | 03    | 06 00 | 31 DC | 02 00        | 31 20  | 00 00 |              |
| AUDIO SOURCE - LAN        | Set              | OFF       | BE EF | 03    | 06 00 | DA DF        | 01 00  | 3B 20 | 00 00        |
|                           |                  | AUDIO IN1 | BE EF | 03    | 06 00 | 4A DE        | 01 00  | 3B 20 | 01 00        |
|                           |                  | AUDIO IN2 | BE EF | 03    | 06 00 | BA DE        | 01 00  | 3B 20 | 02 00        |
|                           |                  | AUDIO IN3 | BE EF | 03    | 06 00 | 2A DF        | 01 00  | 3B 20 | 03 00        |
|                           | AUDIO_LAN        | BE EF     | 03    | 06 00 | 8A D3 | 01 00        | 3B 20  | 11 00 |              |
| Get                       | BE EF            | 03        | 06 00 | E9 DF | 02 00 | 3B 20        | 00 00  |       |              |
| AUDIO SOURCE - USB TYPE A | Set              | OFF       | BE EF | 03    | 06 00 | 76 DD        | 01 00  | 36 20 | 00 00        |
|                           |                  | AUDIO IN1 | BE EF | 03    | 06 00 | E6 DC        | 01 00  | 36 20 | 01 00        |
|                           |                  | AUDIO IN2 | BE EF | 03    | 06 00 | 16 DC        | 01 00  | 36 20 | 02 00        |
|                           |                  | AUDIO IN3 | BE EF | 03    | 06 00 | 86 DD        | 01 00  | 36 20 | 03 00        |
|                           | Get              | BE EF     | 03    | 06 00 | 45 DD | 02 00        | 36 20  | 00 00 |              |
| AUDIO SOURCE - USB TYPE B | Set              | OFF       | BE EF | 03    | 06 00 | AE DE        | 01 00  | 3C 20 | 00 00        |
|                           |                  | AUDIO IN1 | BE EF | 03    | 06 00 | 3E DF        | 01 00  | 3C 20 | 01 00        |
|                           |                  | AUDIO IN2 | BE EF | 03    | 06 00 | CE DF        | 01 00  | 3C 20 | 02 00        |
|                           |                  | AUDIO IN3 | BE EF | 03    | 06 00 | 5E DE        | 01 00  | 3C 20 | 03 00        |
|                           | AUDIO_USB TYPE B | BE EF     | 03    | 06 00 | 0E D2 | 01 00        | 3C 20  | 12 00 |              |
| Get                       | BE EF            | 03        | 06 00 | 9D DE | 02 00 | 3C 20        | 00 00  |       |              |
| AUDIO SOURCE - STANDBY    | Set              | OFF       | BE EF | 03    | 06 00 | EA DE        | 01 00  | 3F 20 | 00 00        |
|                           |                  | AUDIO IN1 | BE EF | 03    | 06 00 | 7A DF        | 01 00  | 3F 20 | 01 00        |
|                           |                  | AUDIO IN2 | BE EF | 03    | 06 00 | 8A DF        | 01 00  | 3F 20 | 02 00        |
|                           |                  | AUDIO IN3 | BE EF | 03    | 06 00 | 1A DE        | 01 00  | 3F 20 | 03 00        |
|                           | HDMI2/MHL        | BE EF     | 03    | 06 00 | BA C6 | 01 00        | 3F 20  | 21 00 |              |
| Get                       | BE EF            | 03        | 06 00 | D9 DE | 02 00 | 3F 20        | 00 00  |       |              |
| LAN SOUND ENABLE          | Set              | Disable   | BE EF | 03    | 06 00 | BA F0        | 01 00  | A3 20 | 00 00        |
|                           |                  | Enable    | BE EF | 03    | 06 00 | 2A F1        | 01 00  | A3 20 | 01 00        |
|                           | Get              | BE EF     | 03    | 06 00 | 89 F0 | 02 00        | A3 20  | 00 00 |              |
| USB TYPE B SOUND ENABLE   | Set              | Disable   | BE EF | 03    | 06 00 | 32 F0        | 01 00  | A5 20 | 00 00        |
|                           |                  | Enable    | BE EF | 03    | 06 00 | A2 F1        | 01 00  | A5 20 | 01 00        |
|                           | Get              | BE EF     | 03    | 06 00 | 01 F0 | 02 00        | A5 20  | 00 00 |              |

(continued on next page)

| Names                    | Operation Type | Header        |       |       |       | Command Data |       |              |       |
|--------------------------|----------------|---------------|-------|-------|-------|--------------|-------|--------------|-------|
|                          |                |               |       |       | CRC   | Action       | Type  | Setting Code |       |
| LANGUAGE *               | Set            | ENGLISH       | BE EF | 03    | 06 00 | F7 D3        | 01 00 | 05 30        | 00 00 |
|                          |                | FRANÇAIS      | BE EF | 03    | 06 00 | 67 D2        | 01 00 | 05 30        | 01 00 |
|                          |                | DEUTSCH       | BE EF | 03    | 06 00 | 97 D2        | 01 00 | 05 30        | 02 00 |
|                          |                | ESPAÑOL       | BE EF | 03    | 06 00 | 07 D3        | 01 00 | 05 30        | 03 00 |
|                          |                | ITALIANO      | BE EF | 03    | 06 00 | 37 D1        | 01 00 | 05 30        | 04 00 |
|                          |                | NORSK         | BE EF | 03    | 06 00 | A7 D0        | 01 00 | 05 30        | 05 00 |
|                          |                | NEDERLANDS    | BE EF | 03    | 06 00 | 57 D0        | 01 00 | 05 30        | 06 00 |
|                          |                | PORTUGUÊS     | BE EF | 03    | 06 00 | C7 D1        | 01 00 | 05 30        | 07 00 |
|                          |                | 日本語           | BE EF | 03    | 06 00 | 37 D4        | 01 00 | 05 30        | 08 00 |
|                          |                | 简体中文          | BE EF | 03    | 06 00 | A7 D5        | 01 00 | 05 30        | 09 00 |
|                          |                | 繁體中文          | BE EF | 03    | 06 00 | 37 DE        | 01 00 | 05 30        | 10 00 |
|                          |                | 한글            | BE EF | 03    | 06 00 | 57 D5        | 01 00 | 05 30        | 0A 00 |
|                          |                | SVENSKA       | BE EF | 03    | 06 00 | C7 D4        | 01 00 | 05 30        | 0B 00 |
|                          |                | РУССКИЙ       | BE EF | 03    | 06 00 | F7 D6        | 01 00 | 05 30        | 0C 00 |
|                          |                | SUOMI         | BE EF | 03    | 06 00 | 67 D7        | 01 00 | 05 30        | 0D 00 |
|                          |                | POLSKI        | BE EF | 03    | 06 00 | 97 D7        | 01 00 | 05 30        | 0E 00 |
|                          |                | TÜRKÇE        | BE EF | 03    | 06 00 | 07 D6        | 01 00 | 05 30        | 0F 00 |
|                          |                | DANSK         | BE EF | 03    | 06 00 | A7 DF        | 01 00 | 05 30        | 11 00 |
|                          |                | ČESKY         | BE EF | 03    | 06 00 | 57 DF        | 01 00 | 05 30        | 12 00 |
|                          |                | MAGYAR        | BE EF | 03    | 06 00 | C7 DE        | 01 00 | 05 30        | 13 00 |
|                          |                | ROMÂNĂ        | BE EF | 03    | 06 00 | F7 DC        | 01 00 | 05 30        | 14 00 |
|                          |                | SLOVENSKI     | BE EF | 03    | 06 00 | 67 DD        | 01 00 | 05 30        | 15 00 |
|                          |                | HRVATSKI      | BE EF | 03    | 06 00 | 97 DD        | 01 00 | 05 30        | 16 00 |
|                          |                | E/MHNIKA      | BE EF | 03    | 06 00 | 07 DC        | 01 00 | 05 30        | 17 00 |
|                          |                | LIETUVIŲ      | BE EF | 03    | 06 00 | F7 D9        | 01 00 | 05 30        | 18 00 |
|                          |                | EESTI         | BE EF | 03    | 06 00 | 67 D8        | 01 00 | 05 30        | 19 00 |
|                          |                | LATVIEŠU      | BE EF | 03    | 06 00 | 97 D8        | 01 00 | 05 30        | 1A 00 |
|                          |                | ไทย           | BE EF | 03    | 06 00 | 07 D9        | 01 00 | 05 30        | 1B 00 |
|                          |                | ةىبرعلا ةغللا | BE EF | 03    | 06 00 | 37 DB        | 01 00 | 05 30        | 1C 00 |
|                          |                | اىسراف        | BE EF | 03    | 06 00 | A7 DA        | 01 00 | 05 30        | 1D 00 |
|                          |                | PORTUGUÊS BRA | BE EF | 03    | 06 00 | 57 DA        | 01 00 | 05 30        | 1E 00 |
|                          |                | BAHASA IND    | BE EF | 03    | 06 00 | C7 DB        | 01 00 | 05 30        | 1F 00 |
| TIENG VIET               | BE EF          | 03            | 06 00 | 37 CA | 01 00 | 05 30        | 20 00 |              |       |
| הירבע                    | BE EF          | 03            | 06 00 | A7 CB | 01 00 | 05 30        | 21 00 |              |       |
|                          | Get            | BE EF         | 03    | 06 00 | C4 D3 | 02 00        | 05 30 | 00 00        |       |
| MENU POSITION H          | Get            | BE EF         | 03    | 06 00 | 04 D7 | 02 00        | 15 30 | 00 00        |       |
|                          | Increment      | BE EF         | 03    | 06 00 | 62 D7 | 04 00        | 15 30 | 00 00        |       |
|                          | Decrement      | BE EF         | 03    | 06 00 | B3 D6 | 05 00        | 15 30 | 00 00        |       |
| MENU POSITION H<br>Reset | Execute        | BE EF         | 03    | 06 00 | DC C6 | 06 00        | 43 70 | 00 00        |       |
| MENU POSITION V          | Get            | BE EF         | 03    | 06 00 | 40 D7 | 02 00        | 16 30 | 00 00        |       |
|                          | Increment      | BE EF         | 03    | 06 00 | 26 D7 | 04 00        | 16 30 | 00 00        |       |
|                          | Decrement      | BE EF         | 03    | 06 00 | F7 D6 | 05 00        | 16 30 | 00 00        |       |
| MENU POSITION V<br>Reset | Execute        | BE EF         | 03    | 06 00 | A8 C7 | 06 00        | 44 70 | 00 00        |       |

\* Not all of the languages in the table are supported.  
(continued on next page)

RS-232C Communication / Network command table (continued)

| Names           | Operation Type | Header       |       |       |       | Command Data |       |              |       |
|-----------------|----------------|--------------|-------|-------|-------|--------------|-------|--------------|-------|
|                 |                |              |       |       | CRC   | Action       | Type  | Setting Code |       |
| BLANK           | Set            | MyScreen     | BE EF | 03    | 06 00 | FB CA        | 01 00 | 00 30        | 20 00 |
|                 |                | ORIGINAL     | BE EF | 03    | 06 00 | FB E2        | 01 00 | 00 30        | 40 00 |
|                 |                | BLUE         | BE EF | 03    | 06 00 | CB D3        | 01 00 | 00 30        | 03 00 |
|                 |                | WHITE        | BE EF | 03    | 06 00 | 6B D0        | 01 00 | 00 30        | 05 00 |
|                 |                | BLACK        | BE EF | 03    | 06 00 | 9B D0        | 01 00 | 00 30        | 06 00 |
|                 | Get            |              | BE EF | 03    | 06 00 | 08 D3        | 02 00 | 00 30        | 00 00 |
| BLANK On/Off    | Set            | OFF          | BE EF | 03    | 06 00 | FB D8        | 01 00 | 20 30        | 00 00 |
|                 |                | ON           | BE EF | 03    | 06 00 | 6B D9        | 01 00 | 20 30        | 01 00 |
|                 | Get            |              | BE EF | 03    | 06 00 | C8 D8        | 02 00 | 20 30        | 00 00 |
| AUTO BLANK      | Set            | BLUE         | BE EF | 03    | 06 00 | 67 D1        | 01 00 | 0D 30        | 03 00 |
|                 |                | WHITE        | BE EF | 03    | 06 00 | C7 D2        | 01 00 | 0D 30        | 05 00 |
|                 |                | BLACK        | BE EF | 03    | 06 00 | 37 D2        | 01 00 | 0D 30        | 06 00 |
|                 | Get            |              | BE EF | 03    | 06 00 | A4 D1        | 02 00 | 0D 30        | 00 00 |
| START UP        | Set            | MyScreen     | BE EF | 03    | 06 00 | CB CB        | 01 00 | 04 30        | 20 00 |
|                 |                | ORIGINAL     | BE EF | 03    | 06 00 | 0B D2        | 01 00 | 04 30        | 00 00 |
|                 |                | OFF          | BE EF | 03    | 06 00 | 9B D3        | 01 00 | 04 30        | 01 00 |
|                 | Get            |              | BE EF | 03    | 06 00 | 38 D2        | 02 00 | 04 30        | 00 00 |
| MyScreen Lock   | Set            | OFF          | BE EF | 03    | 06 00 | 3B EF        | 01 00 | C0 30        | 00 00 |
|                 |                | ON           | BE EF | 03    | 06 00 | AB EE        | 01 00 | C0 30        | 01 00 |
|                 | Get            |              | BE EF | 03    | 06 00 | 08 EF        | 02 00 | C0 30        | 00 00 |
| MESSAGE         | Set            | OFF          | BE EF | 03    | 06 00 | 8F D6        | 01 00 | 17 30        | 00 00 |
|                 |                | ON           | BE EF | 03    | 06 00 | 1F D7        | 01 00 | 17 30        | 01 00 |
|                 | Get            |              | BE EF | 03    | 06 00 | BC D6        | 02 00 | 17 30        | 00 00 |
| TEMPLATE        | Set            | TEST PATTERN | BE EF | 03    | 06 00 | 43 D9        | 01 00 | 22 30        | 00 00 |
|                 |                | DOT-LINE1    | BE EF | 03    | 06 00 | D3 D8        | 01 00 | 22 30        | 01 00 |
|                 |                | DOT-LINE2    | BE EF | 03    | 06 00 | 23 D8        | 01 00 | 22 30        | 02 00 |
|                 |                | DOT-LINE3    | BE EF | 03    | 06 00 | B3 D9        | 01 00 | 22 30        | 03 00 |
|                 |                | DOT-LINE4    | BE EF | 03    | 06 00 | 83 DB        | 01 00 | 22 30        | 04 00 |
|                 |                | CIRCLE 1     | BE EF | 03    | 06 00 | 13 DA        | 01 00 | 22 30        | 05 00 |
|                 |                | CIRCLE 2     | BE EF | 03    | 06 00 | E3 DA        | 01 00 | 22 30        | 06 00 |
|                 |                | MAP 1        | BE EF | 03    | 06 00 | 83 D4        | 01 00 | 22 30        | 10 00 |
|                 | MAP 2          | BE EF        | 03    | 06 00 | 13 D5 | 01 00        | 22 30 | 11 00        |       |
| Get             |                | BE EF        | 03    | 06 00 | 70 D9 | 02 00        | 22 30 | 00 00        |       |
| TEMPLATE On/Off | Set            | OFF          | BE EF | 03    | 06 00 | BF D8        | 01 00 | 23 30        | 00 00 |
|                 |                | ON           | BE EF | 03    | 06 00 | 2F D9        | 01 00 | 23 30        | 01 00 |
|                 | Get            |              | BE EF | 03    | 06 00 | 8C D8        | 02 00 | 23 30        | 00 00 |
| C. C. - DISPLAY | Set            | OFF          | BE EF | 03    | 06 00 | FA 62        | 01 00 | 00 37        | 00 00 |
|                 |                | ON           | BE EF | 03    | 06 00 | 6A 63        | 01 00 | 00 37        | 01 00 |
|                 |                | AUTO         | BE EF | 03    | 06 00 | 9A 63        | 01 00 | 00 37        | 02 00 |
|                 | Get            |              | BE EF | 03    | 06 00 | C9 62        | 02 00 | 00 37        | 00 00 |
| C. C. - MODE    | Set            | CAPTIONS     | BE EF | 03    | 06 00 | 06 63        | 01 00 | 01 37        | 00 00 |
|                 |                | TEXT         | BE EF | 03    | 06 00 | 96 62        | 01 00 | 01 37        | 01 00 |
|                 | Get            |              | BE EF | 03    | 06 00 | 35 63        | 02 00 | 01 37        | 00 00 |
| C. C. - CHANNEL | Set            | 1            | BE EF | 03    | 06 00 | D2 62        | 01 00 | 02 37        | 01 00 |
|                 |                | 2            | BE EF | 03    | 06 00 | 22 62        | 01 00 | 02 37        | 02 00 |
|                 |                | 3            | BE EF | 03    | 06 00 | B2 63        | 01 00 | 02 37        | 03 00 |
|                 |                | 4            | BE EF | 03    | 06 00 | 82 61        | 01 00 | 02 37        | 04 00 |
|                 | Get            |              | BE EF | 03    | 06 00 | 71 63        | 02 00 | 02 37        | 00 00 |

(continued on next page)

## RS-232C Communication / Network command table (continued)

| Names                         | Operation Type | Header |       |       |       | Command Data |       |              |       |
|-------------------------------|----------------|--------|-------|-------|-------|--------------|-------|--------------|-------|
|                               |                |        |       |       | CRC   | Action       | Type  | Setting Code |       |
| SEARCH SKIP -<br>COMPUTER IN1 | Set            | NORMAL | BE EF | 03    | 06 00 | FE 78        | 01 00 | 20 22        | 00 00 |
|                               |                | SKIP   | BE EF | 03    | 06 00 | 6E 79        | 01 00 | 20 22        | 01 00 |
|                               | Get            | BE EF  | 03    | 06 00 | CD 78 | 02 00        | 20 22 | 00 00        |       |
| SEARCH SKIP -<br>COMPUTER IN2 | Set            | NORMAL | BE EF | 03    | 06 00 | CE 79        | 01 00 | 24 22        | 00 00 |
|                               |                | SKIP   | BE EF | 03    | 06 00 | 5E 78        | 01 00 | 24 22        | 01 00 |
|                               | Get            | BE EF  | 03    | 06 00 | FD 79 | 02 00        | 24 22 | 00 00        |       |
| SEARCH SKIP -<br>LAN          | Set            | NORMAL | BE EF | 03    | 06 00 | DA 7A        | 01 00 | 2B 22        | 00 00 |
|                               |                | SKIP   | BE EF | 03    | 06 00 | 4A 7B        | 01 00 | 2B 22        | 01 00 |
|                               | Get            | BE EF  | 03    | 06 00 | E9 7A | 02 00        | 2B 22 | 00 00        |       |
| SEARCH SKIP -<br>USB TYPE A   | Set            | NORMAL | BE EF | 03    | 06 00 | 76 78        | 01 00 | 26 22        | 00 00 |
|                               |                | SKIP   | BE EF | 03    | 06 00 | E6 79        | 01 00 | 26 22        | 01 00 |
|                               | Get            | BE EF  | 03    | 06 00 | 45 78 | 02 00        | 26 22 | 00 00        |       |
| SEARCH SKIP -<br>USB TYPE B   | Set            | NORMAL | BE EF | 03    | 06 00 | AE 7B        | 01 00 | 2C 22        | 00 00 |
|                               |                | SKIP   | BE EF | 03    | 06 00 | 3E 7A        | 01 00 | 2C 22        | 01 00 |
|                               | Get            | BE EF  | 03    | 06 00 | 9D 7B | 02 00        | 2C 22 | 00 00        |       |
| SEARCH SKIP -<br>HDMI 1       | Set            | NORMAL | BE EF | 03    | 06 00 | BA 78        | 01 00 | 23 22        | 00 00 |
|                               |                | SKIP   | BE EF | 03    | 06 00 | 2A 79        | 01 00 | 23 22        | 01 00 |
|                               | Get            | BE EF  | 03    | 06 00 | 89 78 | 02 00        | 23 22 | 00 00        |       |
| SEARCH SKIP -<br>HDMI 2 / MHL | Set            | NORMAL | BE EF | 03    | 06 00 | 52 7A        | 01 00 | 2D 22        | 00 00 |
|                               |                | SKIP   | BE EF | 03    | 06 00 | C2 7B        | 01 00 | 2D 22        | 01 00 |
|                               | Get            | BE EF  | 03    | 06 00 | 61 7A | 02 00        | 2D 22 | 00 00        |       |
| SEARCH SKIP -<br>VIDEO        | Set            | NORMAL | BE EF | 03    | 06 00 | 02 79        | 01 00 | 21 22        | 00 00 |
|                               |                | SKIP   | BE EF | 03    | 06 00 | 92 78        | 01 00 | 21 22        | 01 00 |
|                               | Get            | BE EF  | 03    | 06 00 | 31 79 | 02 00        | 21 22 | 00 00        |       |
| AUTO SEARCH                   | Set            | OFF    | BE EF | 03    | 06 00 | B6 D6        | 01 00 | 16 20        | 00 00 |
|                               |                | ON     | BE EF | 03    | 06 00 | 26 D7        | 01 00 | 16 20        | 01 00 |
|                               | Get            | BE EF  | 03    | 06 00 | 85 D6 | 02 00        | 16 20 | 00 00        |       |
| DIRECT POWER ON               | Set            | OFF    | BE EF | 03    | 06 00 | 3B 89        | 01 00 | 20 31        | 00 00 |
|                               |                | ON     | BE EF | 03    | 06 00 | AB 88        | 01 00 | 20 31        | 01 00 |
|                               | Get            | BE EF  | 03    | 06 00 | 08 89 | 02 00        | 20 31 | 00 00        |       |
| AUTO POWER OFF                | Get            |        | BE EF | 03    | 06 00 | 08 86        | 02 00 | 10 31        | 00 00 |
|                               | Increment      |        | BE EF | 03    | 06 00 | 6E 86        | 04 00 | 10 31        | 00 00 |
|                               | Decrement      |        | BE EF | 03    | 06 00 | BF 87        | 05 00 | 10 31        | 00 00 |
| LAMP TIME LOW                 | Get            |        | BE EF | 03    | 06 00 | C2 FF        | 02 00 | 90 10        | 00 00 |
| LAMP TIME HIGH                | Get            |        | BE EF | 03    | 06 00 | 2A FD        | 02 00 | 9E 10        | 00 00 |
| LAMP TIME Reset               | Execute        |        | BE EF | 03    | 06 00 | 58 DC        | 06 00 | 30 70        | 00 00 |
| FILTER TIME LOW               | Get            |        | BE EF | 03    | 06 00 | C2 F0        | 02 00 | A0 10        | 00 00 |
| FILTER TIME HIGH              | Get            |        | BE EF | 03    | 06 00 | D6 FC        | 02 00 | 9F 10        | 00 00 |
| FILTER TIME Reset             | Execute        |        | BE EF | 03    | 06 00 | 98 C6        | 06 00 | 40 70        | 00 00 |

(continued on next page)

RS-232C Communication / Network command table (continued)

| Names         | Operation Type | Header        |       |       |       | Command Data |       |              |       |
|---------------|----------------|---------------|-------|-------|-------|--------------|-------|--------------|-------|
|               |                |               |       |       | CRC   | Action       | Type  | Setting Code |       |
| MY BUTTON-1   | Set            | COMPUTER IN1  | BE EF | 03    | 06 00 | 3A 33        | 01 00 | 00 36        | 00 00 |
|               |                | COMPUTER IN2  | BE EF | 03    | 06 00 | FA 31        | 01 00 | 00 36        | 04 00 |
|               |                | HDMI1         | BE EF | 03    | 06 00 | CA 33        | 01 00 | 00 36        | 03 00 |
|               |                | HDMI2/MHL     | BE EF | 03    | 06 00 | AA 37        | 01 00 | 00 36        | 0D 00 |
|               |                | VIDEO         | BE EF | 03    | 06 00 | AA 32        | 01 00 | 00 36        | 01 00 |
|               |                | LAN           | BE EF | 03    | 06 00 | 0A 34        | 01 00 | 00 36        | 0B 00 |
|               |                | USB TYPE A    | BE EF | 03    | 06 00 | 9A 30        | 01 00 | 00 36        | 06 00 |
|               |                | USB TYPE B    | BE EF | 03    | 06 00 | 3A 36        | 01 00 | 00 36        | 0C 00 |
|               |                | INFORMATION   | BE EF | 03    | 06 00 | FA 3E        | 01 00 | 00 36        | 10 00 |
|               |                | AUTO KEYSTONE | BE EF | 03    | 06 00 | 6A 3F        | 01 00 | 00 36        | 11 00 |
|               |                | MY MEMORY     | BE EF | 03    | 06 00 | 9A 3F        | 01 00 | 00 36        | 12 00 |
|               |                | ACTIVE IRIS   | BE EF | 03    | 06 00 | AA 3D        | 01 00 | 00 36        | 15 00 |
|               |                | PICTURE MODE  | BE EF | 03    | 06 00 | 0A 3E        | 01 00 | 00 36        | 13 00 |
|               |                | FILTER RESET  | BE EF | 03    | 06 00 | 3A 3C        | 01 00 | 00 36        | 14 00 |
|               |                | AV MUTE       | BE EF | 03    | 06 00 | AA 38        | 01 00 | 00 36        | 19 00 |
|               |                | TEMPLATE      | BE EF | 03    | 06 00 | CA 39        | 01 00 | 00 36        | 1B 00 |
|               |                | RESOLUTION    | BE EF | 03    | 06 00 | 9A 3A        | 01 00 | 00 36        | 1E 00 |
|               |                | ECO MODE      | BE EF | 03    | 06 00 | 0A 25        | 01 00 | 00 36        | 37 00 |
|               |                | MY IMAGE      | BE EF | 03    | 06 00 | 5A 3D        | 01 00 | 00 36        | 16 00 |
|               |                | SLIDESHOW     | BE EF | 03    | 06 00 | 9A 2B        | 01 00 | 00 36        | 22 00 |
|               | MESSENGER      | BE EF         | 03    | 06 00 | AA 29 | 01 00        | 00 36 | 25 00        |       |
| ACCENTUALIZER | BE EF          | 03            | 06 00 | 9A 21 | 01 00 | 00 36        | 3A 00 |              |       |
|               |                | HDCR          | BE EF | 03    | 06 00 | 5A 23        | 01 00 | 00 36        | 3E 00 |
|               | Get            |               | BE EF | 03    | 06 00 | 09 33        | 02 00 | 00 36        | 00 00 |
| MY BUTTON-2   | Set            | COMPUTER IN1  | BE EF | 03    | 06 00 | C6 32        | 01 00 | 01 36        | 00 00 |
|               |                | COMPUTER IN2  | BE EF | 03    | 06 00 | 06 30        | 01 00 | 01 36        | 04 00 |
|               |                | HDMI1         | BE EF | 03    | 06 00 | 36 32        | 01 00 | 01 36        | 03 00 |
|               |                | HDMI2/MHL     | BE EF | 03    | 06 00 | 56 36        | 01 00 | 01 36        | 0D 00 |
|               |                | VIDEO         | BE EF | 03    | 06 00 | 56 33        | 01 00 | 01 36        | 01 00 |
|               |                | LAN           | BE EF | 03    | 06 00 | F6 35        | 01 00 | 01 36        | 0B 00 |
|               |                | USB TYPE A    | BE EF | 03    | 06 00 | 66 31        | 01 00 | 01 36        | 06 00 |
|               |                | USB TYPE B    | BE EF | 03    | 06 00 | C6 37        | 01 00 | 01 36        | 0C 00 |
|               |                | INFORMATION   | BE EF | 03    | 06 00 | 06 3F        | 01 00 | 01 36        | 10 00 |
|               |                | AUTO KEYSTONE | BE EF | 03    | 06 00 | 96 3E        | 01 00 | 01 36        | 11 00 |
|               |                | MY MEMORY     | BE EF | 03    | 06 00 | 66 3E        | 01 00 | 01 36        | 12 00 |
|               |                | ACTIVE IRIS   | BE EF | 03    | 06 00 | 56 3C        | 01 00 | 01 36        | 15 00 |
|               |                | PICTURE MODE  | BE EF | 03    | 06 00 | F6 3F        | 01 00 | 01 36        | 13 00 |
|               |                | FILTER RESET  | BE EF | 03    | 06 00 | C6 3D        | 01 00 | 01 36        | 14 00 |
|               |                | AV MUTE       | BE EF | 03    | 06 00 | 56 39        | 01 00 | 01 36        | 19 00 |
|               |                | TEMPLATE      | BE EF | 03    | 06 00 | 36 38        | 01 00 | 01 36        | 1B 00 |
|               |                | RESOLUTION    | BE EF | 03    | 06 00 | 66 3B        | 01 00 | 01 36        | 1E 00 |
|               |                | ECO MODE      | BE EF | 03    | 06 00 | F6 24        | 01 00 | 01 36        | 37 00 |
|               |                | MY IMAGE      | BE EF | 03    | 06 00 | A6 3C        | 01 00 | 01 36        | 16 00 |
|               |                | SLIDESHOW     | BE EF | 03    | 06 00 | 66 2A        | 01 00 | 01 36        | 22 00 |
|               | MESSENGER      | BE EF         | 03    | 06 00 | 56 28 | 01 00        | 01 36 | 25 00        |       |
| ACCENTUALIZER | BE EF          | 03            | 06 00 | 66 20 | 01 00 | 01 36        | 3A 00 |              |       |
|               |                | HDCR          | BE EF | 03    | 06 00 | A6 22        | 01 00 | 01 36        | 3E 00 |
|               | Get            |               | BE EF | 03    | 06 00 | F5 32        | 02 00 | 01 36        | 00 00 |

(continued on next page)

## RS-232C Communication / Network command table (continued)

| Names                      | Operation Type | Header  |       |       |       | Command Data |       |              |       |
|----------------------------|----------------|---------|-------|-------|-------|--------------|-------|--------------|-------|
|                            |                |         |       |       | CRC   | Action       | Type  | Setting Code |       |
| REMOTE FREQ.<br>NORMAL     | Set            | OFF     | BE EF | 03    | 06 00 | FF 3D        | 01 00 | 30 26        | 00 00 |
|                            |                | ON      | BE EF | 03    | 06 00 | 6F 3C        | 01 00 | 30 26        | 01 00 |
|                            | Get            | BE EF   | 03    | 06 00 | CC 3D | 02 00        | 30 26 | 00 00        |       |
| REMOTE FREQ.<br>HIGH       | Set            | OFF     | BE EF | 03    | 06 00 | 03 3C        | 01 00 | 31 26        | 00 00 |
|                            |                | ON      | BE EF | 03    | 06 00 | 93 3D        | 01 00 | 31 26        | 01 00 |
|                            | Get            | BE EF   | 03    | 06 00 | 30 3C | 02 00        | 31 26 | 00 00        |       |
| MY IMAGE                   | Set            | OFF     | BE EF | 03    | 06 00 | 3A C3        | 01 00 | 00 35        | 00 00 |
|                            |                | IMAGE-1 | BE EF | 03    | 06 00 | AA C2        | 01 00 | 00 35        | 01 00 |
|                            |                | IMAGE-2 | BE EF | 03    | 06 00 | 5A C2        | 01 00 | 00 35        | 02 00 |
|                            |                | IMAGE-3 | BE EF | 03    | 06 00 | CA C3        | 01 00 | 00 35        | 03 00 |
|                            | IMAGE-4        | BE EF   | 03    | 06 00 | FA C1 | 01 00        | 00 35 | 04 00        |       |
| Get                        | BE EF          | 03      | 06 00 | 09 C3 | 02 00 | 00 35        | 00 00 |              |       |
| MY IMAGE IMAGE-1<br>Delete | Execute        | BE EF   | 03    | 06 00 | 71 C3 | 06 00        | 01 35 | 00 00        |       |
| MY IMAGE IMAGE-2<br>Delete | Execute        | BE EF   | 03    | 06 00 | 35 C3 | 06 00        | 02 35 | 00 00        |       |
| MY IMAGE IMAGE-3<br>Delete | Execute        | BE EF   | 03    | 06 00 | C9 C2 | 06 00        | 03 35 | 00 00        |       |
| MY IMAGE IMAGE-4<br>Delete | Execute        | BE EF   | 03    | 06 00 | BD C3 | 06 00        | 04 35 | 00 00        |       |



## PJLink command

| Commands | Control Description    | Parameter or Response |
|----------|------------------------|-----------------------|
| POWR     | Power Control          | 0 = Standby           |
|          |                        | 1 = Power On          |
| POWR ?   | Power Status inquiry   | 0 = Standby           |
|          |                        | 1 = Power On          |
|          |                        | 2 = Cool Down         |
| INPT     | Input Source selection | 11 = COMPUTER IN 1    |
|          |                        | 12 = COMPUTER IN 2    |
|          |                        | 23 = VIDEO            |
|          |                        | 31 = HDMI1            |
|          |                        | 33 = HDMI2/MHL        |
|          |                        | 41 = USB TYPE A       |
|          |                        | 51 = LAN              |
|          |                        | 52 = USB TYPE B       |
| INPT ?   | Input Source inquiry   | 11 = COMPUTER IN 1    |
|          |                        | 12 = COMPUTER IN 2    |
|          |                        | 23 = VIDEO            |
|          |                        | 31 = HDMI1            |
|          |                        | 33 = HDMI2/MHL        |
|          |                        | 41 = USB TYPE A       |
|          |                        | 51 = LAN              |
|          |                        | 52 = USB TYPE B       |
| AVMT     | AV Mute                | 10 = BLANK off        |
|          |                        | 11 = BLANK on         |
|          |                        | 20 = Mute off         |
|          |                        | 21 = Mute on          |
|          |                        | 30 = AV Mute off      |
|          |                        | 31 = AV Mute on       |
| AVMT ?   | AV Mute inquiry        | 10 = BLANK off        |
|          |                        | 11 = BLANK on         |
|          |                        | 20 = Mute off         |
|          |                        | 21 = Mute on          |
|          |                        | 30 = AV Mute off      |
|          |                        | 31 = AV Mute on       |

(continued on next page)

| Commands | Control Description       | Parameter or Response  |
|----------|---------------------------|--|
| ERST ?   | Error Status inquiry      | 1st byte: Refers to Fan error; one of 0 to 2   |
|          |                           | 2nd byte: Refers to Lamp error; one of 0 to 2  |
|          |                           | 3rd byte: Refers to Temperature error; one of 0 to 2   |
|          |                           | 4th byte: Refers to Cover error; one of 0 to 2   |
|          |                           | 5th byte: Refers to Filter error; one of 0 to 2  |
|          |                           | 6th byte: Refers to Other error; one of 0 to 2   |
|          |                           |  |
|          |                           | The meaning of 0 to 2 is as given below<br>0 = Error is not detected; 1 = Warning; 2 = Error |
| LAMP ?   | Lamp Status inquiry       | 1st number (digits 1 to 5): Lamp Time  |
|          |                           | 2nd number : 0 = Lamp off, 1 = Lamp on   |
| INST ?   | Input Source List inquiry | 11 12 23 31 33 41 51 52  |
| NAME ?   | Projector Name inquiry    | Responds with the name set in "PROJECTOR NAME" of "NETWORK"                                  |
| INF1 ?   | Brand Name inquiry        | HITACHI  |
| INF2 ?   | Model Name inquiry        | CP-EX5001WN  |
|          |                           | CP-EW5001WN  |
| INFO ?   | Other Information inquiry | Responds with the factory information and so on  |
| CLSS ?   | Class Information inquiry | 1  |

NOTE • The password used in PJLink™ is the same as the password set in the Projector Web Control. To use PJLink™ without authentication, do not set any password in Projector Web Control.

• For specifications of PJLink™, see the website of the Japan Business Machine and Information System Industries Association.

URL: <http://pjlink.jbmia.or.jp/>